



# Air Handlers



**THERMAL**  
CORPORATION

*A Division of Nailor International, Inc.*





## AIR HANDLERS AND EQUIPMENT

**THERMAL**  
CORPORATION

*A Division of Nallor International Inc.*

**THERMAL CORPORATION offers a full range of air handling products and services. We have built a solid reputation for design and engineering excellence, performance, flexibility and creativity in meeting the needs of our customers. Whether you require a basic setup or need to customize your projects, we are capable and ready to assist you.**



### **THERMAL QUALITY**

Because Thermal Corporation has manufactured quality air handling equipment since 1945 using only the finest materials, equipment and design expertise, many tens of thousands of THERMAL air handlers remain in service after 40-50 years and longer.

### **QUICK DELIVERY**

Since we stock a number of fans and also manufacture dampers and accessories, most air handlers can be shipped within 6-8 weeks of approval. Premium, expedited deliveries of 2-4 weeks are routinely available when necessary.



## Contents

	Page No.
<b>Features</b>	<b>A2</b>
<b>Applications</b>	<b>A5</b>
<b>Components</b>	
• Fans	<b>A8</b>
• Coils	<b>A13</b>
<b>Nomenclature / Ordering</b>	<b>A14</b>
<b>Selection</b>	
• CF Series	<b>A15</b>
• F Series	<b>A23</b>
• TS Series	<b>A31</b>
• T Series	<b>A39</b>
<b>Component Selection</b>	
• Fan Selection	
• Forward Curved	<b>A48</b>
• Airfoil	<b>A50</b>
• Plenum - Motor Beside Configuration	<b>A52</b>
• Plenum - Motor Behind Configuration	<b>A53</b>
• Filter Selection	<b>A54</b>
• Mixing Selection	<b>A55</b>
• Cooling Coil Selection	<b>A56</b>
• Air Pressure Drop	<b>A57</b>
<b>Guide Specifications</b>	
• Indoor	<b>A58</b>
• Outdoor	<b>A64</b>



## Indoor and Outdoor Air Handler Typical Features

### GENERAL:

#### Flexibility

When a project demands technical requirements beyond the capability of a traditional air handler, a Flexible design is essential to providing the solution. Thermal Corporation defines Flexibility. Offering Custom Air Handling Equipment in both a horizontal and vertical configuration, complete with a variety of inlet and discharge arrangements, mechanical components and uniquely fabricated structural frames, each Thermal Air Handler is engineered to deliver results.

Horizontal configured units may be constructed for indoor or outdoor use. Each can be mounted to a floor, roof curb or even ceiling suspended. Vertical units are typically designed for indoor use and floor mounted; however, the flexibility afforded Thermal allows for unlimited possibilities. Often units with multiple fans are stacked into a configuration that reduces overall footprint and ensures the most economical use of mechanical room area. To further illustrate Thermal's engineered flexibility, all Thermal Air handlers can be constructed with one sided access, greatly increasing air handler location options.

#### Engineered for Longevity

Whether the Air Handling unit will be in place 50+ years, or needs to be disassembled to fit through a fixed opening, diverse structural frame construction methods ensure Thermal Corporation's Air Handlers outlast the test of time. For example, attaching double-wall panel systems to the structural frame means insulation is not exposed to the airstream, thus increasing the longevity of the insulation. Providing hinged doors in almost any location, allows internally mounted components to be accessed for service or cleaning. Internally mounted motors and drives operate in a clean environment, providing increased life spans.

Due to the flexible nature of the structural frame and the purposeful engineering of associated components, Thermal designed Air Handling Equipment will provide years of reliable performance.

### COMPONENTS:

#### Inlet hood

Outdoor air handler's inlet section typically includes an Inlet hood. Inlet hood with available screen, protects internal components from entering rain, snow, debris and animals.

#### Louver

A louver is a window frame type construction with horizontal slats that are angled to admit air, but to keep out rain and debris.

#### Damper

Dampers used in air handling units typically are rectangle shape with multiple damper blades in parallel or opposed configurations. Air damper controls or stops the flow of air inside a duct or air handler equipment and its operation can be manual or automated.

**Parallel Blade:** The blades of a parallel blade damper remain parallel to each other throughout the rotation cycle. This arrangement allows the damper to direct the air as it moves through them, which can be an advantage in a mixing situation but has a higher pressure through them.

**Opposed Blade:** Opposed blades damper configuration has a linkage arrangement that causes pairs of blades to rotate towards each other as the damper rotates. As a result, the air stream experiences very little change in direction as it passes through the damper. When compared to a parallel blade damper with identical dimensions and the same air flow across it, an opposed blade damper will achieve a linear flow characteristic with less pressure drop.

**Airfoil Blade:** An extruded Aluminum airfoil blade provides a rigid assembly that is resistant to fluctuate at high velocities and helps to ensure good blade seal compression. Airfoil damper offers a lower pressure drop compare to a formed sheet metal damper configuration, which can be an advantage in overall system design.

#### Filter

Air filter is constructed from fibrous materials which removes solid particulates such as dust, pollen, mold and bacteria from the air. A chemical air filter consists of an absorbent or catalyst for the removal of airborne molecular contaminants. Air filters are used in applications where air quality is important, particularly in building ventilation systems. American Society of Heating, Refrigeration and Air Conditioner Engineers (ASHRAE) developed Minimum Efficiency Reporting Value (MERV) rating to evaluate air filter effectiveness. MERV values vary from 1 to 16, the higher value more efficient the filter will be in blocking air borne particles. Consider selecting an air handler with dirty filters so that, in theory, the unit will have enough horsepower to deliver the same amount of air when the filters are dirty.

- 2 in. (51 mm) or 4 in. (102 mm) flat filters
- 2 in. (51 mm) or 4 in. (102 mm) angle filters
- Side loading 6 or 12 in. (152 or 304 mm) cartridge filters with 2 in. (51 mm) pre-filters
- Side loading 21 in. (533 mm) bag filters with 2 in. (51 mm) pre-filters
- Face loading bag/cartridge filters without pre-filters
- HEPA face loading filters with or without pre-filters

#### Air blender

An air blender or static mixing device is constructed of several angle blades positioned in multiple circular orientations. Air blender used in HVAC equipment to prevent air stratification causes many challenges in proper design and operation of air handling units. Most notable problems are: poor temperature control, frosted coil and uneven velocity profile.

#### HRW

Heat recovery wheel is a rotating matrix of finely corrugated metal, operating in both opposing airstreams. When the system is in heating mode, heat is absorbed as air passes through the matrix in the exhaust airstream, during one half rotations and released during the second half rotation into the supply airstream in a continuous process.

#### Plate Heat Exchanger

A sandwich of plastic or metal plates with interlaced air paths. Heat is transferred between airstreams from one side of the plate to the other. The plates are typically spaced at 5/16" (4 mm) to 1/4" (6 mm) apart.



# Indoor and Outdoor Air Handler Typical Features

## Heat Pipe

Heat pipe is operating in both opposing air paths, using a confined refrigerant as a heat transfer medium. The heat pipe uses multiple sealed pipes mounted in a coil configuration with fins to increase heat transfer. Heat is absorbed on one side of the pipe, by evaporation of the refrigerant and released at the other side, by condensation of the refrigerant. Condensed refrigerant flows by gravity to the first side of the pipe to repeat the process.

- Wrap around Heat pipe uses for dehumidification and reheat application.
- Fixed slab heat pipe typically installed in dual air streams for continuous heating or cooling application.
- Tilt packed heat pipe has capability of modulating heat pipe slab in response to the space thermostat to control cooling and heating requirements.

## Run Around coils

Two heat exchanger coils in opposing airstreams, piped together with a circulating pump uses water or a mix of water and antifreeze as the heat transfer medium. This device, although not very efficient, allows heat recovery between remote and sometimes multiple supply and exhaust airstreams.

## Coil selection

Thermal air handlers have a wide selection of coils to meet your application needs. All coils have high-performance coil surface; the coil tubes are mechanically expanded into the fins for improved fin bonding and peak thermal transfer. All vent and drain connections are easily accessible. Optional copper fins and stainless steel casings are available for all coils.

## Chilled water coils

These coils have headers precisely sized to minimize water pressure loss. Chilled water coils are manufactured of 0.5 in. (13 mm) OD copper tubes. These coils range from 1 to 8 rows and aluminum fins 8, 10, 12, or 14 fins per inch (314, 394, 472, or 551 fins per meter). Copper and coated fins are optional. Steel coil connectors with male pipe thread are standard.

## Direct expansion coils

Coils are available in large or medium face area, with 4, 6 or 8 rows. The tubes are made of 0.375 in. (10 mm) OD copper with aluminum fins and 8, 10, 12 or 14 fins per inch (314, 394, 472 or 551 fins per meter). Copper and coated fins are available as an option. Choose from quarter, half, full, or double circuits. Most direct expansion coils have at least two splits allowing you to match a coil with one or two condensing units for independent refrigerant systems.

## Hot water coils

Hot water coils are designed to provide heating capability for a complete range of applications, at a working pressure of 250 psig (18.3 bars) at 300°F (149°C). Hot water coils are offered in 1, 2 or 4 rows, with fin spacing of 8, 10, 12 or 14 fins per inch (314, 394, 472 or 551 fins per meter). Coils have aluminum fins with copper tubes (copper and coated fins are available). Hot water coils are also available with face and bypass options.

## Steam coils

The steam coils are designed for a working pressure of 150 psig (11.4 bars) at 360°F (182°C). The steam coil is available in 1 or 2 rows in 1 in. (25 mm) OD copper tubes with 6, 8, 10 or 12 aluminum fins per inch (236, 314, 394 or 472 fins per meter). Steam coils are available with bypass face areas and are sloped to drain condensate. Steam coils are especially suited to applications where sub-freezing air enters the air-handling unit or where uniformity of leaving-air temperature is required.

## Stainless steel Coil Drain Pan

Drain pan is sloped toward the drain to remove condensate completely. This eliminates build-up of stagnant water during shutdown periods and keeps the air handler free of odors and bacteria. Stainless steel provides an easy-to clean surface that resists corrosion.

## UV Lights

UV light reduces the spread of airborne microorganisms that trigger allergy and asthma symptoms and reduces the spread of bacteria and viruses that can cause infectious diseases. It lowers energy costs by improving HVAC system heat transfer and increasing net cooling capacity. UV light continuously cleans coils, drain pan, plenum and ducts reducing or eliminating manual cleaning and the use of harmful chemicals.

## Electric heat coil

Electric heat coils may be ordered for factory installation into the electric heat section. Units with electric heat are designed in accordance to the UL (Underwriters Laboratories) 1995.

## Fan

Choose from airfoil, forward-curved and plenum fans based on first cost and performance requirements. As standard, pillow-block bearings are rated at 200,000 hours average life (L50) in all sizes of airfoil, forward curved and plenum fans.

- DWDI

Forward Curved Centrifugal Fan (FC) blades curve toward direction of rotation. It runs at relatively low speed and is suitable for low to medium pressure air handling applications.

Backward Inclined Centrifugal Fan (BI) blades are constructed from a flat piece of steel and curved away from direction of rotation. BI fans are suitable for high speed and pressure applications.

Airfoil Centrifugal Fan (AF) blades have aerodynamic shape construction similar to airplane wing and they are curved away from direction of rotation. AF fans are suitable for high speed and pressure applications.

- Plenum

Plenum Fan (PF) blades have aerodynamic shape construction similar to airplane wing and they are curved away from direction of rotation. Plenum fans can be used in high speed and pressure applications and they are a suitable option for limited space or multiple duct connections.

## Indoor and Outdoor Air Handler Typical Features

### Motor

We offer belt driven or direct drive motors in wide range of motor horse powers, voltages and standard or premium efficiencies.

- ODP

Open Drip Proof, a type of electric motor enclosure that has vents to allow air flow but to prevent liquid from entering the motor.

- TEFC

Totally Enclosed Fan Cooled, this type of motor is constructed with a small fan on the rear shaft of the motor and covered with housing. This fan draws air over internal components to remove excess heat and cool the motor.

### Isolation

The blower and motor assembly in an air handler can create considerable vibration that can be transmitted via air duct system to the occupant's space. To eliminate or minimize vibration, flexible canvas isolators are installed between inlet and outlet of unit and air duct system. The rubberized canvas material allows the air handler components to vibrate without transmitting this motion to the attached ducts. The fan compartment can be further isolated by placing it on a spring suspension, which will mitigate the transfer of vibration through the floor and walls.

- Pad
- Rubber-In-Shear (RIS)
- Spring
- Duct Canvas Connect

### Gas Heat (Indirect Fire)

Indirect-fired gas heater burns natural or propane gas which produces a flame that heats an internal tubes or a primary drum within the unit heater. A blower forces air over the heated chamber and the heated air are then transferred into space. These heaters are vented to the atmosphere which means that no exhaust gases from the burning of the gas enter the heated space.

- Tubular gas heater construction consists of formed tube as heat exchanger.
- Drum & tube gas heater uses a primary drum for combustion and a set of tubes for heat exchanger, which based on number of passes can be categorized as standard or high efficiency.

### Humidifier

Humidifier package can be installed in HVAC equipment that improves comfort heating during cold season. A humidifier is a device that increases moisture level in a space.

### Silencer

Silencers are used in HVAC system for commercial, institutional and residential buildings to reduce mechanical equipment noise transmitted through the ducting system achieving desired noise criteria in the occupied space.

### Door

Thermal Corp. offers optional high performance double wall access doors with aluminum frame and viewing window for air handling units. These doors are available in Outswing rotation for sections with negative pressure which are typically located upstream of blower section and Inswing rotation for air handler with Plenum fan option or any section(s) downstream of blower with positive pressure. These types of doors will eliminate any air leakage through access doors.

### Marine Light & Light Switch

Optional Marine light fixture (weather proof) may be ordered for factory installation for both inside and outside of the air handler unit. We also offer weather proof light switch with or without LED night light.

### Ground Fault Circuit Interrupter (GFCI)

Optional weather proof power outlet or GFCI outlet can be installed inside or outside of equipment for convenient use.

#### Service Platform

Thermal Corp. fabricates and installs landing and service platforms for a custom application. These platforms provide safe access to an air handler or rooftop equipment. Custom fabricated from structural steel, the landing platform features skid resistant stair treads and safety guard rails that comply with OSHA regulations.

### Components for customizing standard units

Thermal Corp. offers special third party items such as integral face and bypass (IFB) coil, Enthalpy Wheel, Plate Heat Exchanger, Heat Pipe, humidifier, air blenders and evaporative coolers which can be factory mounted.



## Applications

Custom applications demand the utmost in flexibility. Using a variety of structural frame designs, Thermal has the unparalleled ability to construct custom air handling equipment for custom applications. Combine the unique flexibility of structural design with 60+ years of experience and add in the almost limitless ability to customize components, the result yields proven designs, accommodating the most demanding projects.

There is only one application typical for Thermal's Air Handling Equipment; moving air. All other requirements, parameters, design constraints, unique features or control, are all determined by individual project specifications. Whether the requirement calls for basic air handling or more complicated energy recovery, or a mix of applications in-between, Thermal's dedicated design team and unique design features provide the solution. Described below are a few applications where Thermal Air Handlers are routinely applied.

### Central Plant Air Handler

The central Plant air handler is a heating, ventilating or air-conditioning unit that is centrally located in or on a building or structure. The air handler distributes air to desired areas through a system of ducts.

### Factory Packaged Unit

Individual components such as fans, coils and filters, are assembled at the factory. Packaged equipment is less costly than field-fabricated equipment and does not require assembly. The basic air-handling unit consists of filter, coil and fan sections. Other components, such as mixing air and access sections may also be provided.

### Central Plant Air Handler Configurations

#### Draw-thru units:

Draw-through units have the coil(s) on the low-pressure or inlet side of the supply fan. The air passes through the dampers and filters before entering the coils. This minimizes the distance between the coils and the fan inlet while still providing uniform air flow through the coils. The fan then discharges the air either directly into a duct or into a discharge plenum with multiple ducts openings. Thermal storage and cold air distribution systems benefit from blow-thru applications. With a draw-thru unit, the airstream must be sub-cooled to anticipate the addition of motor heat downstream of the cooling coil.

#### Horizontal

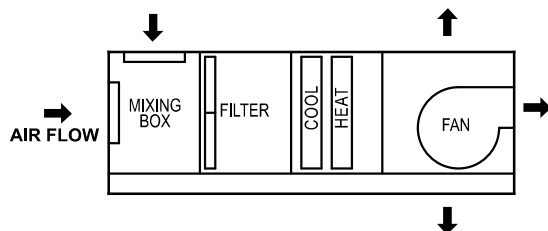

#### Vertical (indoor unit only)

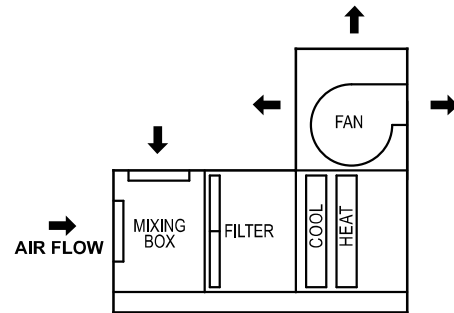

#### Stacked return fan

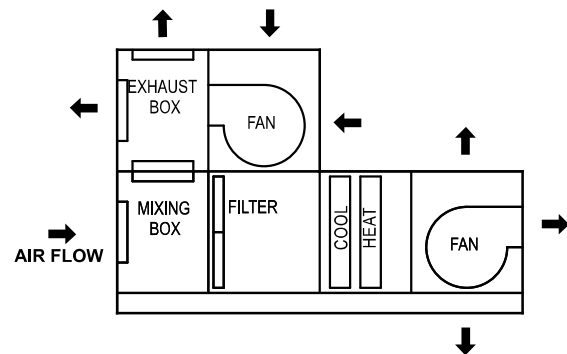

#### Face and bypass units

##### Horizontal

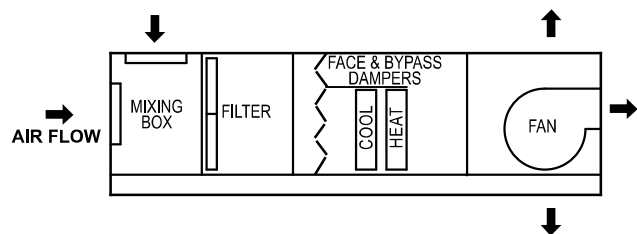

#### Blow-thru units

Blow-through units are the opposite of the draw-through systems. Blow-thru arrangements are more suitable on systems with a significant amount of motor heat. Therefore, on such systems, it is more efficient to use a blow-thru arrangement and add the motor heat before the cooling coil. The coils are located on the high-pressure or downstream of the fan. Because fan discharge air is turbulent, the coil must be far enough from the fan to ensure sufficiently laminar air flow for effective heat transfer. These systems are usually larger than draw-through units. Alternately, a pressure plate can be installed downstream from the fan discharge to ensure laminar air flow across the coil. This option will shorten the unit casing length but increases pressure drop in the system which result in increasing energy use.

## Applications

### Air mixing using a plenum fan

An air blender is only effective between 800 and 1000 FPM (4.1 and 5.1 m/s). Using a blow-thru plenum fan as the air mixing device assures proper mixing at all airflows. This arrangement is best for VAV systems and will eliminate the added expense of a static air blender and eliminates associated pressure drop.

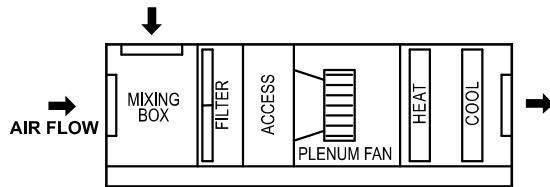

### Dual duct

The unit has 2 supply air openings; one outlet dedicated to hot air while the other produces cold air.

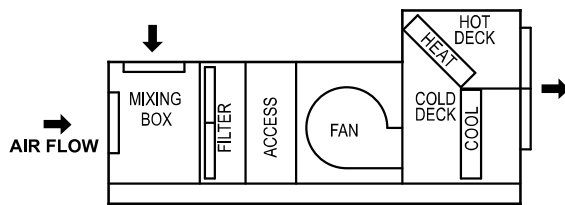

### Multizone

Each Multizone independent zone mixing damper blends hot and cold decks' air to desired temperature to achieve zones thermostat setting.

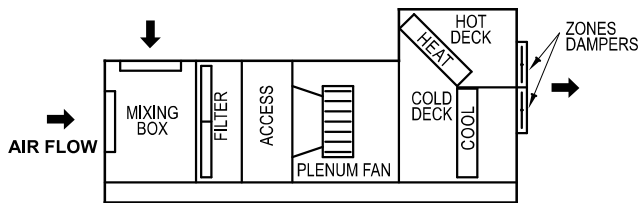

### High filtration units

High filtration units employ several filter sections in different locations of the air handler. Normally this type of unit has pre-filter section which consists of low and medium efficiency filters at the inlet and a second filter section with high efficiency filters, upstream of discharge opening where the air enters the ductwork.

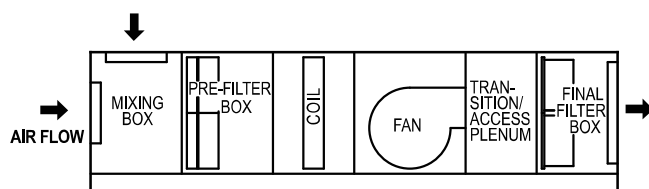

### Energy Recovery Units

#### HRW

Heat recovery wheel is a rotating matrix of finely corrugated metal, operating in both opposing airstreams. When the system is in heating mode, heat is absorbed as air passes through the matrix in the exhaust airstream, during one half rotations and released during the second half rotation into the supply airstream in a continuous process.

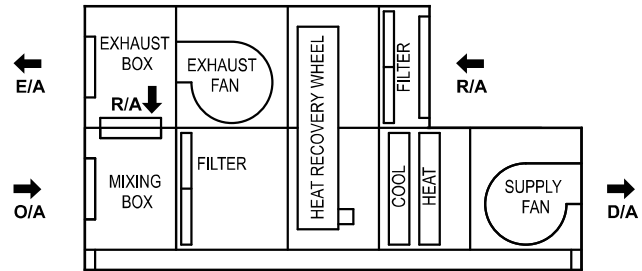

#### Plate Heat Exchanger

A sandwich of plastic or metal plates with interlaced air paths. Heat is transferred between airstreams from one side of the plate to the other. The plates are typically spaced at 5/16" (4 mm) to 1/4" (6 mm) apart.

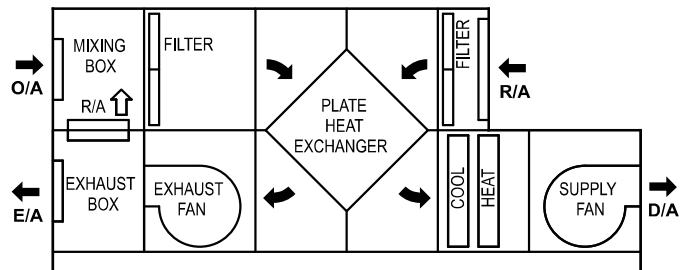

#### Heat Pipe

Heat pipe is operating in both opposing air paths, using a confined refrigerant as a heat transfer medium. The heat pipe uses multiple sealed pipes mounted in a coil configuration with fins to increase heat transfer. Heat is absorbed on one side of the pipe, by evaporation of the refrigerant and released at the other side, by condensation of the refrigerant. Condensed refrigerant flows by gravity to the first side of the pipe to repeat the process.

**Wrap around Heat pipe** uses for dehumidification and reheat application.

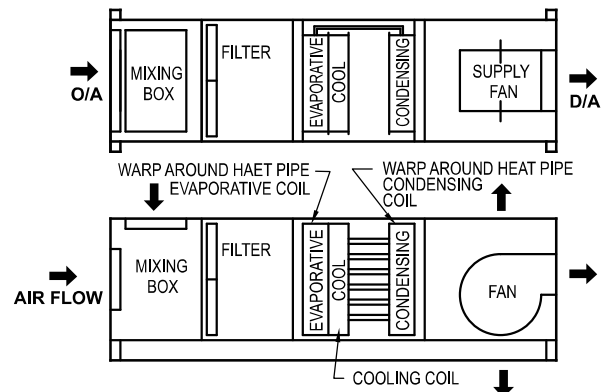



## Applications

**Fixed slab Heat pipe** typically installed in dual air streams for continuous heating or cooling application.

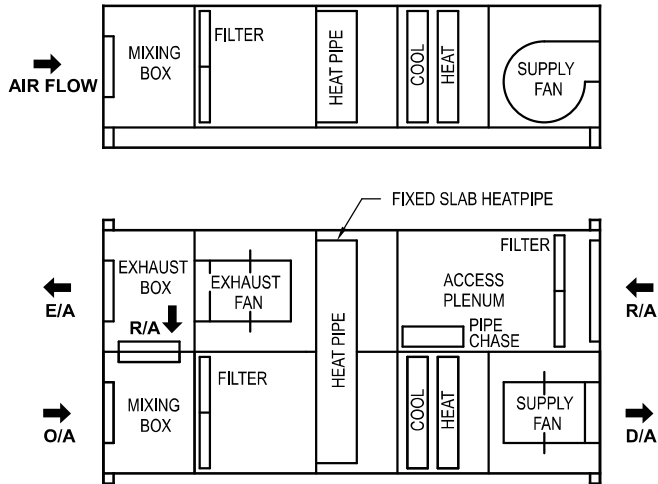

**Tilt packed heat pipe** has capability of modulating heat pipe slab in response to the space thermostat to control cooling and heating requirements.

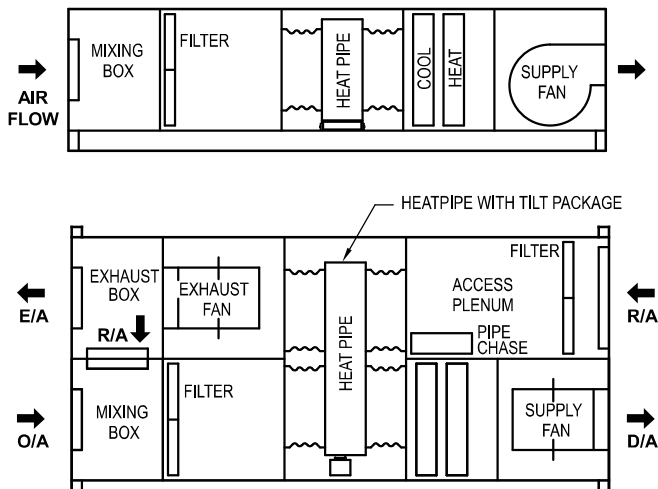

### Run Around coils

Two heat exchanger coils, in opposing airstreams, piped together with a circulating pump and using water and antifreeze mixture as the heat transfer medium. This device, although not very efficient, allows heat recovery between remote and sometimes multiple supply and exhaust airstreams.

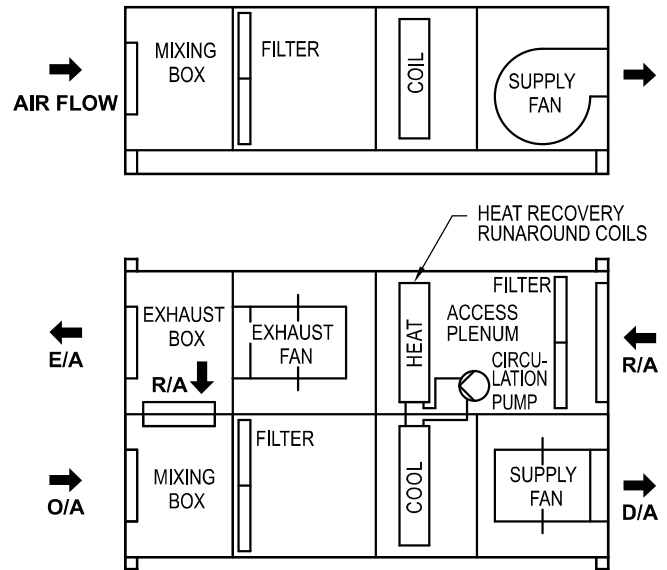

### Gas Heat (Indirect Fire)

Indirect-fired gas heater burns natural or propane gas produces a flame that heats an internal tubes or a primary drum within the unit heater. A blower forces air over the heated chamber and the heated air are then transferred into space. These heaters are vented to the atmosphere which means that no exhaust gases from the burning of the gas enter the heated space. The Duct Furnace standard requires that furnaces be applied and located on the positive pressure side of the circulating air fan only.

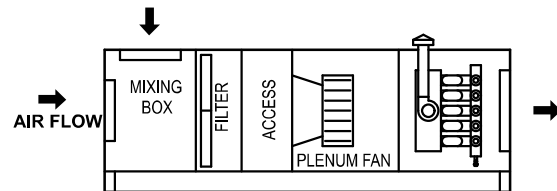

## Fans

Thermal Corporation air handlers use belt-drive or direct drive centrifugal fans. A centrifugal fan is one in which the air flows radially through the impeller. Centrifugal fans are classified according to fan wheel and blade construction. Air handler fans can be selected as double width, double inlet (DWDI) with forward curved or airfoil blades. Plenum fans are selected as single width, single inlet (SWSI) with airfoil blades.

### Fan Selection Criteria

The factors that influence fan selection are airflow (CFM/m<sup>3</sup>/hr.), total static pressure (TSP), fan speed (RPM), brake horsepower (BHP/Kw) and sound level (dB). Fan control methods, high altitude and motor overloading must be considered as well. Generally, smaller fans provide a balance of performance and efficiency for air conditioning applications.

### Sound considerations

The fan is one of the main sound sources in an air-conditioning system. Other sources of sound include the duct systems and terminals because they generate turbulence due to air flow.

Simply estimating fan borne sound does not give an accurate picture of total system sound. To minimize sound generation, a fan must be correctly sized and selected to operate at or near peak efficiency. Oversized fans can generate much higher sound power levels than necessary.

Undersized fans can also result in higher sound power levels because of increased fan speed and the higher tip velocity of the air leaving the fan blades.

Variable Frequency Drives (VFDs) are used to modulate fan volume. A VFD reduces the sound power level as the fan speed is reduced. When using variable frequency drives, it is important that the static deflection of the vibration isolators is adequate. At very low fan speeds, the fan frequency may approach the natural frequency of the spring isolation. If this happens, the vibration levels can be amplified and resonant vibration conditions can occur.

When sound level is a major consideration, a blow-thru fan should be considered because of the reduced discharge sound level. This sound reduction is due to the sound absorption of the coil section downstream from the fan. Transition fittings and elbows can be reduced in size or eliminated, thereby eliminating a sound source.

### Dirty filtration considerations

Consider selecting an air handler with loaded filters so that, in theory, the unit will have enough horsepower to deliver the same amount of air when the filters are loaded. On a constant volume unit, this would only work if the unit contained an airflow measuring station and could adjust the flow accordingly, using a VFD.

### Fan application

Certain fans are more efficient in low static pressure systems, while others operate best in higher pressure systems. Some fan types are designed to handle very large air volumes while others are more efficient at lower volumes.

### Fan Types:

#### Airfoil (AF) Fan

AF fans are most efficient at higher static pressures (4.0 to 8.0 in. w.g. [0 to 1.99 KPa] TSP) because of the geometry of the AF fan blades. On the performance curve of an AF fan, BHP (Kw) decreases as air volume decreases only when a VAV volume control device, such as a VFD, is used. Airfoil fans are more expensive than BI and FC fans.

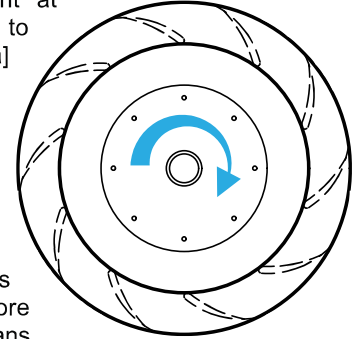

#### Backward Inclined (BI) Fan

Efficiency is slightly less than that of the airfoil design. Backward inclined or backward curved blades are single thickness with blades curved or inclined away from the direction of rotation. Air leaves the impeller at velocity less than its tip speed. Backward inclined deep blades provide efficient expansion with the blade passages.

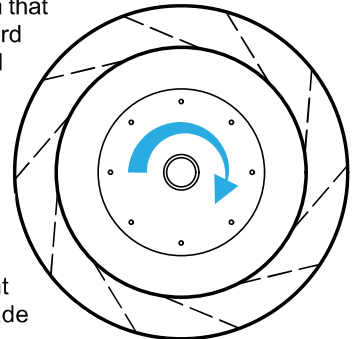

#### Forward-Curved (FC) Fan

FC fans are typically used for low to medium pressure applications (0 to 5 in. w.g. [0 to 1.24 KPa] TSP). The FC fans are reasonably stable over a wide airflow (CFM / m<sup>3</sup>/hr.) range at constant speed. Because of the relatively flat performance, FC fans tolerate moderation in airflow without large increases in static pressure. Most importantly, FC fans have the lowest initial cost.

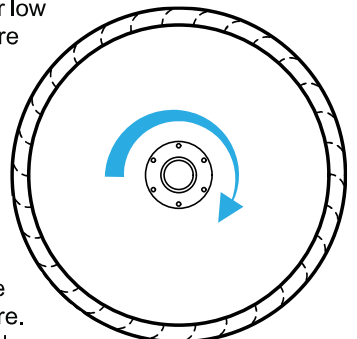

#### Plenum Fans (PF)

Plenum fans are typically used in medium to high static pressure applications where ductwork requires discharge location flexibility. Plenum fans can be used in both belt driven or direct drive configurations. They can reduce the need for ductwork turns or diffusers, especially when equipment room space is limited.

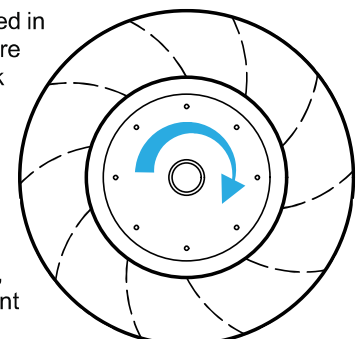



## Fans

Plenum fans are less efficient than double-width, double inlet airfoil fans. General construction also differs from that of FC or AF fans. The fan does not have a scroll to enclose the fan wheel and direct airflow. Instead, the entire interior of the plenum fan section is pressurized by the fan. Plenum fans have single-width, single-inlet (SWSI) construction. The fan shaft is parallel with the airflow and the motor and bearings are located inside the plenum in the pressurized airstream.

An optional inlet screen and wheel cage can be installed to help protect personnel during maintenance. Plenum fans are generally used where there are space limitations, a need for discharge flexibility and an application where there is not enough room in the building for a large main duct; several smaller ducts run may approach the mechanical equipment room from all sides. In such an application, several connections can be made to one or more sides of the plenum fan section. Installing contractors can cut outlets in the plenum box at the time of installation to suit the conditions at the jobsite because the casing of a plenum fan section acts as a sound attenuator. Plenum fans are also sometimes used when discharge sound levels need to be reduced. Duct takeoffs from plenum fans can have relatively high pressure losses and can also create turbulence that causes a larger pressure drop across coil and filter sections. When selecting a plenum fan, the pressure drop for the duct takeoffs must be added to the external static pressure for the rest of the system.

### Direct Drive Fan vs. Belt Drive Fan

#### Direct drive fan

- No power transmission losses - Less operation power required
- No belt residue – Extend filters replacement time
- No bearings in the fan inlet – Reduced service and maintenance costs and increase performance
- Easy to clean fan assembly – Better indoor air quality
- Less load on motor bearing – Extend motor life operation
- Speed control with VFD – Variable flow applications
- Low vibration levels – Smooth and quiet operation, less noise pollution
- Motor directly connected to wheel – Space saving and smaller unit foot print design
- Reduced weight – Easy handling
- Direct drive fan requires a larger motor to provide proper horsepower at rated RPM.

#### Belt drive fan

- Power transmission losses through belt and pulleys – More power required
- Belt residue – Frequent filters replacement
- Bearings in the fan inlet – Increase service and maintenance costs
- Hard to clean fan assembly – less desirable indoor air quality
- Belt tension load on motor bearing – Increase motor's bearing failure
- Noise – Belt drive creates vibration that increase noise level

- Motor mounting – Larger unit foot print design
- Extra weight – Extra framing requires for motor installation
- Smaller motor – less initial cost
- No VFD – Approximate RPM setting with variable pitch pulley

#### Fan Laws

Fan laws are used to predict fan performance under changing operating conditions or by fan size. They are applicable to all types of fans. The fan laws are stated below. The symbols used in the formulas represent the following variables:

CFM (m<sup>3</sup>/hr.): Volume rate of flow through the fan.

RPM: Rotational speed of the impeller.

HP (Kw): Horsepower input to the fan.

Application of these laws is limited to cases where fans are geometrically similar.

- Airflow varies directly with the speed.  
 $CFM1/CFM2 = RPM1/RPM2$
- Pressure varies as the square of the speed.  
 $P1/P2 = (RPM1/RPM2)^2$
- Horsepower varies as the cube of the speed.  
 $HP1/HP2 = (RPM1/RPM2)^3$

#### Motor

An electric motor is an electromechanical device that converts electrical energy into mechanical energy.

#### ODP

Open Drip Proof, a type of electric motor enclosure that has vents to allow air flow but to prevent liquid from entering the motor.

#### TEFC

Totally Enclosed Fan Cooled, this type of motor is constructed with a small fan on the rear shaft of the motor and covered with housing. This fan draws air over internal components to remove excess heat and cool the motor.

#### Motor Insulation Classes

Electric motor insulation classes are rated by their resistance to thermal degradation. The four basic insulation system normally encountered are class A, B, F and H. Class 'A' has a temperature rating of 221°F (105°C) and each step class increase from A to B, B to F and F to H by 77°F (25°C). The insulation class in any motor must be able to withstand at least the maximum ambient temperature plus the temperature rise that occurs as a result of continuous full load operation.

#### Motor Service Factors

Some motors can be specified with service factors other than 1. This means the motor can handle loads above the rated horsepower. A motor with a 1.15 service factor can handle a 15% overload, so a 15 horsepower motor can handle 17.25 HP of load. In general for good motor reliability, service factor should not be used for basic load calculations. By not loading the motor into the service factor under normal use the motor can better withstand adverse conditions that may occur such as voltage fluctuations, higher ambient temperature or occasional overload.

## Fans

### Belt Drives

Most fan drive systems are based on the standard 'V' belt which is relatively efficient and readily available in the market. The use of belt drive allows fan RPM to be selected through a combination motor RPM and drive pulleys ratios.

Drives should be installed with provision for center to center distance adjustment.

Sheaves center to center distance should not exceed 3 times the sum of the pulleys diameter nor less than the diameter of the larger pulley.

Arc contact of the belt on the smaller sheave should not be less than 120°.

To prevent premature belt failure, motor and fan shafts must be in parallel position and drives need to be installed in line.

Don't use force to install or remove sheave off of shafts, make sure the keyway are smooth and clean and keys are correct size.

Belts should never be forced or rolled over sheaves. More belts are broken from this practice than from actual failure in service.

Check belt tension and alignment during the first 24 hours of operation.

### Bearing life

Bearing life is determined in accordance with International Standard Organization (ISO) or the Anti Friction Bearing Manufacturing Association (AFBMA) standards. The life of a rolling element bearing is defined as the number of operating hours at a given load and speed the bearing is capable of enduring before the first signs of failure start to occur. Since identical bearings under identical operating conditions will fail at different times, life is specified in both hours and statistical probability that a certain percentage of bearings can be expected to fail within that time period, for example L10, 40,000 hours. This specification can be interpreted as that a minimum of 90% of the bearings in this category will operate at least 40,000 hours or longer or in another word 10% of the bearings will fail within 40,000 hours of operation.

### Variable Frequency Drive:

Variable Frequency Drive (VFD) usage has increased in HVAC applications in recent years. The VFDs are now commonly applied to air handlers, pumps and tower fans. A better understanding of VFDs will lead to improved application and selection of both equipment and HVAC systems. Other names for a VFD are variable speed drive, adjustable speed drive, adjustable frequency drive, AC drive and inverter.

### VFD Operation:

The basic principles of how VFD operates, requires understanding three basic sections of the VFD.

- Rectifier
- DC bus
- Inverter

Typical three phase industrial electric power consists of 3 alternating currents of equal frequency differing in phase of 120 degrees from each other. The voltage on an Alternating Current (AC) power supply rises and falls in the pattern of a

sine wave. When the voltage is positive, current flows in one direction; when the voltage is negative, the current flows in the opposite direction.

The Rectifier in a VFD is used to convert incoming AC power into Direct Current (DC) power. One rectifier will allow power to pass through, only when the voltage is positive and second rectifier will allow power to pass through, only when the voltage is negative. Two rectifiers are required for each phase of power. Since most large power supplies are three phase, there will be a minimum of 6 rectifiers used.

Rectifiers may utilize diodes which are the simplest device and allow power to flow any time voltage is of the proper polarity.

After the power flows through the rectifiers, it is stored on a DC bus. The DC bus contains capacitors to accept power from the rectifier that stores it and later delivers that power through the inverter section. The DC bus may also contain inductors, dc links, chokes or similar items that add inductance, thereby smoothing the incoming power supply to the DC bus.

The final section of the VFD is referred to as an Inverter. The inverter contains transistors that deliver power to the motor. The Insulated Gate Bipolar Transistor (IGBT) is a common choice in modern VFDs. The IGBT can switch on and off several thousand times per second and precisely control the power delivered to the motor. The IGBT uses a method named Pulse Width Modulation (PWM) to simulate a current sine wave at the desired frequency to the motor. Motor speed (RPM) is dependent upon frequency.

Varying the frequency output of the VFD controls motor speed:

Speed (RPM) = frequency (Hz) x 120 / no. of poles

Example:

4-pole motor at different frequencies

1800 RPM = 60 Hz x 120 / 4

1500 RPM = 50 Hz x 120 / 4

1200 RPM = 40 Hz x 120 / 4

As VFD usage in HVAC applications has increased, air handlers can benefit from speed control. Variable frequency drives provide the following advantages:

- Energy savings
- Low motor starting current
- Reduction of thermal and mechanical stresses on motors and belts during starts
- Simple installation

### VFD Application Motor Criteria

Standard three-phase AC motors, designed for fixed speed operations at standard line frequency, may be easily adapted for use with Variable Frequency Drive (VFD) by considering the following:

1. A slight increase in motor losses occurs with inverter power.
2. The motor thermal capacity must typically be de-rated as a function of the continuous minimum operating speed due to the reduced ventilation provided by the integral motor fan.

Where the application requires 100% rated torque at speeds below 50% of synchronous speed, a separately powered ventilation blower, a thermal overload device or a motor with higher rated capacity should be used. When a separately

## Fans

Rated HP @ 1750 RPM	HP Rating at Various Motor RPM								
	1575	1400	1225	1050	875	700	525	350	175
1	0.90	0.80	0.70	0.60	0.50	0.40	0.30	0.20	0.10
1.5	1.35	1.20	1.05	0.90	0.75	0.60	0.45	0.30	0.15
2	1.80	1.60	1.40	1.20	1.00	0.80	0.60	0.40	0.20
3	2.70	2.40	2.10	1.80	1.50	1.20	0.90	0.60	0.30
5	4.50	4.00	3.50	3.00	2.50	2.00	1.50	1.00	0.50
7.5	6.75	6.00	5.25	4.50	3.75	3.00	2.25	1.50	0.75
10	9.00	8.00	7.00	6.00	5.00	4.00	3.00	2.00	1.00
15	13.50	12.00	10.50	9.00	7.50	6.00	4.50	3.00	1.50
20	18.00	16.00	14.00	12.00	10.00	8.00	6.00	4.00	2.00
25	22.50	20.00	17.50	15.00	12.50	10.00	7.50	5.00	2.50
30	27.00	24.00	21.00	18.00	15.00	12.00	9.00	6.00	3.00
40	36.00	32.00	28.00	24.00	20.00	16.00	12.00	8.00	4.00
50	45.00	40.00	35.00	30.00	25.00	20.00	15.00	10.00	5.00
60	54.00	48.00	42.00	36.00	30.00	24.00	18.00	12.00	6.00
75	67.50	60.00	52.50	45.00	37.50	30.00	22.50	15.00	7.50
100	90.00	80.00	70.00	60.00	50.00	40.00	30.00	20.00	10.00

NOTE: Shaded area, motors may require supplemental cooling when operated continuously at rated load at reduced speeds.

HP Rating at Various Motor Heat Gain from Typical Electric Motor		
Rated HP @ 1750 RPM	Motor Efficiency %	Motor Heat BTU/H
1	75	3390
1.5	77	4960
2	79	6440
3	81	9430
5	82	15500
7.5	84	22700
10	85	29900
15	86	44400
20	87	58500
25	88	72300
30	89	85700
40	89	114000
50	89	143000
60	89	172000
75	90	212000
100	90	283000

powered ventilation blower is used, a thermostat should be built into the motor to prevent damage which may result from a failure in the ventilation system.

### AC vs. DC Drive Comparison

AC and DC drives both continue to offer unique benefits and features that may make one type or other better suited for certain applications.

#### AC Drives:

- They use conventional, low cost, 3-phase AC induction motors for most applications.
- AC motors require virtually no maintenance and are preferred for applications where the motor is mounted in an area not easily reached for servicing or replacement.
- AC motors are smaller, lighter, more commonly available and less expensive than DC motors.
- AC motors are better suited for high speed operation (over 2500 rpm) since there are no brushes and commutation is not a problem.
- Whenever the operating environment is wet, corrosive or explosive and special motor enclosures are required. Special AC motor enclosure types are more readily available at lower prices.
- Multiple motors in a system must operate simultaneously at a common frequency/speed.
- It is desirable to use an existing constant speed AC motor already mounted and wired on a machine.
- When the application load varies greatly and light loads may be encountered for prolonged periods. DC motor commutator and brushes may wear rapidly under this condition.
- Low cost electronic motor reversing is required.
- It is important to have a backup (constant speed) if the controller should fail.

#### DC Drives:

- DC drives are less complex with a single power conversion from AC to DC.
- DC drives are normally less expensive for most horsepower ratings.
- DC motors have a long tradition of use as adjustable speed machines and a wide range of options have evolved for this purpose:
- Cooling blowers and inlet air flanges provide cooling air for a wide speed range at constant torque.
- Accessory mounting flanges and kits for mounting feedback tachometers and encoders.
- DC regenerative drives are available for applications requiring continuous regeneration for overhauling loads. AC drives with this capability would be more complex and expensive.
- Properly applied, brush and commutator maintenance is minimal.
- DC motors are capable of providing starting and accelerating torques in excess of 400% of rated.
- Some AC drives may produce audible motor noise which is undesirable in some applications.

#### Isolation

The blower and motor assembly in an air handler can create considerable vibration that can be transmitted via air duct system to the occupant's space. To eliminate or minimize vibration, flexible canvas isolators are installed between inlet and outlet of unit and air duct system. The rubberized canvas material allows the air handler components to vibrate without transmitting this motion to the attached ducts. The fan compartment can be further isolated by placing it on a spring suspension, which will mitigate the transfer of vibration through the floor and walls.



## Fans

### Mounting Options:

- Pad

A neoprene pad may provide adequate isolation when properly installed. Excess compression can crush the pad and turn it essentially rigid and no longer provides proper isolation. A good rule of thumb is no more than 25% compression of the pads should be under load or under fastener tension.



- Rubber-In-Shear (RIS)

Rubber mountings are an effective, low cost solution designed to isolate high speed mechanical equipment such as fan and motor assemblies. Rubber's natural properties also offer a damping effect, which when combined with its static deflection properties, create higher isolation efficiency.



- Spring

Spring isolators are described in terms of the "static deflection". Static deflection is how far spring compresses under the weight of the equipment. If a spring is 2" (51 mm) long when unloaded and compresses to 1" when carrying the weight, we say that it has 1" (25 mm) of static deflection.



- Duct Canvas Connect

All air duct installations for heating, cooling or ventilation are attached to HVAC equipment, which contains a fan motor assembly. Vibrations, noises and rattles resulting from operation of the fan will be transmitted into the metal ducts which carry the noises throughout the duct system.

In order to isolate the vibration and noises to the source, an air-tight flexible joint consisting of a fabric which is secured to sheet metal on both sides, must be inserted between the equipment and the ductwork. This flexible joint is called a Flexible Duct Connector.



## Coils

### Coil definitions

A coil, as the term is used with air-handling equipment, is a heat exchange device. A heating or cooling medium passes through the coil, where it either rejects heat to or absorbs heat from, the airstream passing over the coil, depending upon the relative temperatures of the medium and airstream.

### Tube

The tube is a small-diameter pipe through which the heating or cooling medium passes as it rejects or absorbs heat. Coil tubes are generally constructed of copper but may be made of other metals.

### Fin

The coil fin is a thin metal plate attached to the tube to improve the heat transfer efficiency from medium to airstream. Typically, it is made of either aluminum or copper.

### Header

The header is a large diameter pipe to which several tubes are connected. It distributes the heating or cooling medium to the tubes. Headers are typically of nonferrous metal or steel.

### Casing

The supporting metal structure for tubes and header is called a casing. It is usually made of galvanized steel but can be made of other materials such as stainless steel.

### Inlet and outlet

These are pipe stubs on the header where the heating or cooling medium enters and leaves the coil.

In water coils, the supply inlet is the pipe stub located on the side where the air leaves the coil. The outlet is the stub on the entering air side of the coil. Such arrangement is known as counter flow. In steam coils, the inlet is always the higher stub so that condensate will drain out of the lower stub.

### Finned area (face area)

The working area of the coil is defined as the width X length of the finned area through which air passes. This finned or face area does not include the casing.

### Face velocity

This is the air velocity in FPM (m/s) across the finned or face area of a coil. Face velocity is determined by dividing the air volume in CFM (m<sup>3</sup>/hr.) by the coil face area in FT<sup>2</sup> (m<sup>2</sup>). The first step in selecting an air handler size is to determine the maximum allowable face velocity.

#### 400 – 450 FPM (2.0 – 2.3 m/s):

Coils within this velocity range are commonly used for high humidity application. Air handler unit requires a larger foot print and higher cost to manufacture.

#### 450 – 500 FPM (2.3 – 2.5 m/s):

This velocity range represents most standard HVAC application; air handler builds around these velocities have a good foot print and cost balance.

#### 500 – 600 FPM (2.5 – 3.0 m/s):

If design conditions permit, this is the best selection for cost and space requirement.

#### 600 – 700 FPM (3.0 – 3.6 m/s):

Best option for heating application only, since there will be no moisture carry over.

### Direct expansion (DX) coils

Direct expansion coils can have two intertwined refrigerant circuits. In addition, quarter, half, full and double circuiting configurations are offered to allow optimum system performance and oil return at full and part-load operation. Circuiting selection should result in a circuit loading of 0.8 to 2.0 tons per circuit at design load. Circuit loading must be evaluated at minimum load to ensure that it does not drop below 0.6 tons per circuit. Solenoid valves may be used, if necessary, to shut off the refrigerant supply to individual expansion valves to maintain adequate coil circuit loading.

### Coil Coating

#### Heresite Coating

Heresite is a baked phenolic that is used as a protective coating for heat transfer equipment. Heresite creates a minimal loss of thermal conductivity and has superior salt water, corrosive and chemical fumes resistance, durable finish and outstanding bond strength. It will withstand thermal shock and temperatures up to 400 degrees Fahrenheit, also operating at subzero temperatures without loss of chemical and mechanical properties.

A spray and bake process is used for blower's fan wheel and housing and multiple dipping and bake process for complete coverage of coil's fins and tubes.

Heresite coating offers an economical alternative to the use of different types of metals for corrosive environments. For example, aluminum fin coils coated with Heresite are more economical than copper fin coils and stainless steel coil casing is unnecessary since the Heresite coating is applied to the casing, as well as to the finned tubes.

#### Electro Coating

Electro coating is the process by which a coil is submerged in a paint/water bath where electricity is used to deposit paint onto it. In this process, the coil acts in the same way as a magnet. The coating molecules are electrically attracted to the metallic coil surfaces, meaning the entire coil is completely and uniformly to coastal marine air, industrial and urban environments.

When coils are to be subjected to ultraviolet light exposure, they receive a spray applied UV-resistant topcoat. As a result, electro coating protected from UV light degradation and film integrity is maintained.

Coil will have a flexible epoxy polymer coating uniformly applied to all coil surface areas with no material bridging between fins. The coating process will ensure complete coil encapsulation and a uniform dry film thickness on all surface areas including fin edges.

### Filters

Air is contaminated in varying degrees by soil, organic matter, spores, bacteria, smoke, dust and fumes.

Air cleaning and filtration devices are required in order to create a clean work environment, reduce cleaning costs and extend the life of machinery or equipment.

### Size selection

This catalog has been designed to provide a quick and accurate means of selecting and specifying an air handling unit. Start with the information you have: required airflow and preferred coil face velocity to select a nominal unit size.

## Model Number Nomenclature

### Prefix:

None = Classic Welded Frame  
F = Formed Frame  
T = Tubular Frame  
T<sup>2</sup> or TS = Foam panel

### Base Model Type:

CXP = Central Plant Unit  
MXT = Multizone Unit  
HXT = Heating Unit  
RTA = Roof Top Unit  
RTAU = Roof Top Air Handler with Utility Compartment  
RTH = Roof Top Air Handler Unit  
RTHU = Roof Top Hospital Unit with Utility Compartment  
RTM = Roof Top Multizone Air Handler Unit  
RTMU = Roof Top Multizone with Utility Compartment  
RX = Energy Recovery Unit  
BBC = Belt Drive Blower Coil Unit  
DBC = Direct Drive Blower Coil Unit  
TCU = Column Unit  
FS = Fan Section  
CS = Coil Section  
FT = Filter Section  
MB = Mixing Box

### X Variable:

L = Low Pressure  
M = Medium Pressure  
H = High Pressure

### Model Size Designation:

Coil  
Number of Fans  
CFM

### Orientation:

H = Horizontal  
V = vertical  
A = 45° Angle  
V1 = Vortex Induction  
T1 = Top Inlet

### Model Specific Modifier:

S = Special  
ZD = Zone Damper  
DD = Dual Duct  
I = Indoor  
O = Outdoor  
Z = 2 Pipe (Chilled Water Coil)  
ZW = 4 Pipe (Chilled & Hot Water Coils)  
E = Electric Heat  
ZE = 2 Pipe (Chilled Water Coil with Electric Heat Coil)

### Example: FCLP-500-H

F Series, Central Plant Low Pressure Unit, 5,000 CFM, Horizontally oriented.



# CF Series: Classic Welded Frame



## Unit Selection Guidelines

### Classic Welded Frame Construction

Thermal Corporation's **CF Series** (Classic Welded Frame) air handlers are constructed around a welded formed frame. This type of unit is built to last and is able to sustain high static pressure with minimum structural deflection. CF Series are available in wide range of sizes and configurations.

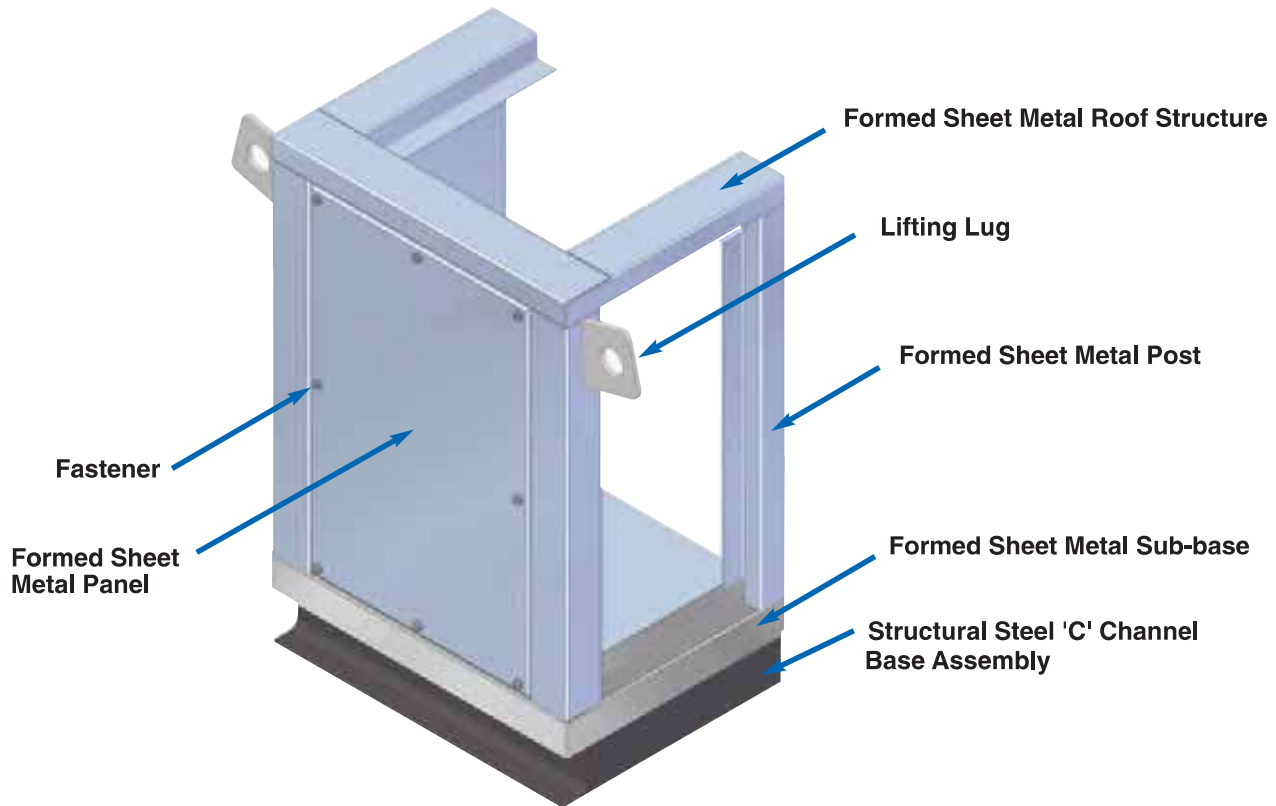

### Construction Features:

- 16 gauge (1.5 mm) galvanized steel panels with closed cell neoprene gasket around the perimeter. All panels are installed with 1/4" (6 mm) sealed fasteners. Panels can be removed without affecting the structural integrity of the formed sheet metal frame.
- 2" (51 mm), 3" (76 mm) or 4" (102 mm) thick walls with single or double wall construction.
- Structural steel fan bases are internally spring-isolated.
- AMCA-rated forward-curved (DWDI), housed airfoil (DWDI) or plenum fans (SWSI) are available.
- Full walk-on floor of galvanized steel. True "double bottom" construction with 4" (102 mm) thick insulation.
- AHRI certified coils in 1/2" (12 mm) or 5/8" (16 mm) O.D. copper tubes. 1" (25 mm) O.D. steam distributing coils are also available upon request.

### Design Flexibility:

- Units are customized to your particular application.
- Wide ranges of unit sizes are available based on CFM (m<sup>3</sup>/hr.) requirement.
- Units can be designed for indoor or outdoor applications. (Only indoor units are available in vertical configurations.)

- Special third-party vendor items such as humidifiers, air blenders, evaporative coolers and integral face & bypass (IFB) coils can be factory mounted.
- Units can be designed with multiple fans for lower profiles or redundant operations.
- Full selection of air filters to meet indoor air quality standards.
- Outdoor units can be provided with roof curbs.

### Shipping

Flatbed trailers are used to ship air handling units that are less than or equal to 108" (2743 mm) tall and 102" (2591 mm) wide. Units less than or equal to 144" (3658 mm) wide and 312" (7925 mm) in direction of airflow can be built and shipped as one piece. Demounts should be added when using these dimensions. As long as there are no shipping limitations, multiple section air handlers ship as a single factory assembled unit. Modular sections may then be demounted in the field by others. Contact factory for units which exceed 133" (3378 mm) tall or 138" (3505 mm) wide.

- For 3" (76 mm) thick casing walls, add 2" (51 mm) to the unit length, width and height.
- For 4" (102 mm) thick casing walls, add 4" (102 mm) to the unit length, width and height.

# Unit Selection Guidelines

## Classic Welded Frame Construction

### All Dimensions based on 2" (51 mm) thick casing walls

- For 3" (76 mm) thick casing walls, add 2" (51 mm) to the unit length, width and height.
- For 4" (102 mm) thick casing walls, add 4" (102 mm) to the unit length, width and height.

### Getting Started

The following information must be known in order to properly design a Thermal custom air handling unit:

1. Total Unit Supply Airflow (CFM/m<sup>3</sup>/hr.)
2. Total Static Pressure (in. w.g./Pa)
3. Unit Configuration
4. Coil Conditions
5. Filtration Requirements

If you are only provided with the external static pressure (ESP) use the quick pressure drop tables on the following pages to establish the total static pressure (TSP) of the unit.

#### Step 1:

Using a copy of the selection template provided at the back of the selection catalog, select whether the unit is indoor or outdoor. Next, enter the CFM (m<sup>3</sup>/hr.) and TSP of each fan.

#### Step 2:

Now that you have established the TSP and CFM (m<sup>3</sup>/hr.) use the fan selection software to pick the proper fan(s). Make sure to record the type of fan(s), required horsepower(s) and motor frame size(s).

#### Fan Type Guidelines

The fans that produce the highest mechanical efficiency are DWDI housed airfoil. However, when you have a blow through application, un-ducted discharge system effect losses often offset their efficiency. While DWDI housed airfoil fans can be used in applications greater than 4" w.g. (995 Pa), DWDI forward curved fans offer quiet operation for return air applications and static pressures less than 4" w.g. (995 Pa).

SWSI Plenum fans pressurize the entire plenum and generate very little velocity pressure, making them ideal for blow through applications and multiple supply air duct openings requirement. While most manufacturers use 8 or 9 bladed plenum fan wheels, Thermal Corporation uses 12 bladed fan wheels.

#### Step 3:

Record the minimum cabinet height and length required for your fan from the fan reference tables. Motor position and size determine the minimum cabinet width.

#### Step 4:

Now turn to the unit selection table. Locate the selection that meets your airflow requirements using your total airflow. Move right and down to any other block that will work if cabinet height and width is less than the minimum required for the fan. Enter the cabinet size in the space provided on the selection template.

#### Step 5:

From the unit selection grid, enter the coil finned height and width. Proceed to the component section and select the required modules.

**Note:** Alternate unit sizes are available. Use the following guidelines to help figure out available fin height and length for a given unit height and width:

#### Fin Height

1. Standard units with 1 coil high, allow fin height + 11" (279 mm)
2. Standard units with 2 coils high, allow fin height + 13" (330 mm)
3. Standard units with 3 coils high, allow fin height + 15" (381 mm)

#### Fin Length

1. Standard units with 1 coil wide, allow fin length + 14" (356 mm)
2. Outdoor units with a 12" (305 mm) internal pipe chase, allow total fin length + 30" (762 mm)

#### Miscellaneous Options

1. Cleanable return bends, allow fin length + 15" (381 mm)
2. 4" (102 mm) connections, allow fin height + 12" (305 mm) and fin length + 16" (406 mm)

**Note:** These guidelines do not include outdoor roof pitch and are based on 5" (127 mm) unit base, 2" (51 mm) casing and up to 3" (76 mm) coil connections.



**CF Series Unit Dimensions • Flat Filter and Coil Selection Table**

**IMPERIAL**

Cabinet	UW	30	36	42	48	54	60	66	72	78	84
UH	Coil	FL16	FL22	FL28	FL34	FL40	FL46	FL52	FL58	FL64	FL70
28	FH15	(1) 12x24	(1) 12x24	(1) 12x24	(1) 12x24	(2) 12x24	(2) 12x24	(2) 12x24	(2) 12x24		
		2.00 / 1000	2.00 / 1000	2.00 / 1000	2.00 / 1000	4.00 / 2000	4.00 / 2000	4.00 / 2000	4.00 / 2000		
33	FH21	(1) 20x24	(1) 20x24	(1) 20x24	(2) 20x20	(2) 20x24	(2) 20x24	(3) 20x20	(3) 20x20	(3) 20x24	(4) 20x20
		3.33 / 1665	3.33 / 1665	3.33 / 1665	5.56 / 2780	6.67 / 3335	6.67 / 3333	8.33 / 4165	8.33 / 4165	10.00 / 5000	11.11 / 5555
37	FH24	(1) 24x24	(1) 12x24 (1) 20x24	(2) 20x24	(2) 24x24	(1) 12x24 (2) 20x24	(1) 12x24 (2) 24x24	(2) 20x24 (2) 24x24	(2) 20x24 (1) 24x24	(3) 24x24	(4) 20x24
		4.00 / 2000	5.33 / 2665	6.67 / 3335	8.00 / 4000	8.67 / 4335	10.00 / 5000	10.67 / 5335	12.00 / 6000	13.33 / 6665	
39	FH27	(1) 24x24	(1) 12x24 (1) 24x24	(2) 20x24	(2) 24x24	(1) 12x24 (2) 20x24	(1) 12x24 (2) 24x24	(2) 20x24 (2) 24x24	(2) 20x24 (1) 24x24	(3) 24x24	(4) 20x24
		2.00 / 1000	6.00 / 3000	6.67 / 3335	8.00 / 4000	8.67 / 4335	10.00 / 5000	10.67 / 5335	12.00 / 6000	13.33 / 6665	
45	FH33	(1) 12x24 (1) 20x24	(1) 12x24 (1) 20x24	(2) 20x24	(2) 24x24	(2) 12x24 (2) 20x24	(2) 12x24 (2) 20x24	(2) 12x24 (2) 20x24	(2) 12x24 (2) 20x24	(3) 12x24 (3) 20x24	(3) 12x24 (3) 20x24
		5.33 / 2665	5.33 / 2665	10.67 / 5335	10.67 / 5335	10.67 / 5335	10.67 / 5335	10.67 / 5335	10.67 / 5335	16.00 / 8000	16.00 / 8000
50	FH39	(1) 12x24 (1) 24x24	(4) 20x20	(4) 20x24	(4) 20x24	(6) 20x20	(6) 20x20	(6) 20x20	(6) 20x20	(6) 20x24	(6) 20x24
		6.00 / 3000	11.11 / 5555	13.33 / 6665	13.33 / 6665	16.67 / 8335	16.67 / 8335	20.00 / 10000	20.00 / 10000	20.00 / 10000	20.00 / 10000
53	FH42	(1) 12x24 (1) 24x24	(4) 20x20	(4) 20x24	(4) 20x24	(6) 20x20	(6) 20x20	(6) 20x20	(6) 20x20	(6) 20x24	(8) 20x20
		7.58 / 3790	9.21 / 4605	10.83 / 5415	12.46 / 6230	14.08 / 7040	15.71 / 7855	17.33 / 8665	18.96 / 9480	20.59 / 10290	22.22 / 11110
57	FH45	(1) 12x24 (1) 24x24	(4) 20x20	(4) 20x24	(4) 20x24	(6) 20x20	(6) 20x20	(6) 20x20	(6) 20x20	(6) 20x24	(8) 20x24
		9.92 / 4960	11.67 / 5835	13.42 / 6710	15.17 / 7585	16.92 / 8460	18.67 / 9335	20.42 / 10210	22.17 / 11085	23.92 / 11960	25.67 / 12835
60	FH48	(1) 12x24 (1) 24x24	(4) 20x20	(4) 20x24	(4) 20x24	(6) 20x20	(6) 20x20	(6) 20x20	(6) 20x20	(6) 20x24	(8) 20x24
		12.50 / 6250	14.38 / 7190	16.25 / 8125	18.13 / 9065	20.00 / 10000	21.88 / 10940	23.75 / 11875	25.63 / 12815	27.50 / 13750	29.38 / 14690
66	FH54	(1) 12x24 (1) 24x24	(4) 20x20	(4) 20x24	(4) 20x24	(6) 20x20	(6) 20x20	(6) 20x20	(6) 20x20	(6) 20x24	(8) 20x24
		17.50 / 8750	19.50 / 9750	21.75 / 10875	24.00 / 12000	26.25 / 13125	28.50 / 14250	30.75 / 15375	33.00 / 16500	35.25 / 17625	37.50 / 18750
73	FH(2)30	(1) 12x24 (1) 24x24	(4) 20x20	(4) 20x24	(4) 20x24	(6) 20x20	(6) 20x20	(6) 20x20	(6) 20x20	(6) 20x24	(8) 20x24
		21.67 / 10835	24.17 / 12085	26.67 / 13335	29.17 / 14585	31.67 / 15835	34.17 / 17085	36.67 / 18335	39.17 / 19585	41.67 / 20835	44.17 / 22085
81	FH(2)33	(1) 12x24 (1) 24x24	(4) 20x20	(4) 20x24	(4) 20x24	(6) 20x20	(6) 20x20	(6) 20x20	(6) 20x20	(6) 20x24	(8) 20x24
		26.58 / 13290	29.33 / 14665	32.08 / 16040	34.83 / 17415	37.58 / 18790	40.33 / 20165	43.08 / 21540	45.83 / 22915	48.58 / 24290	51.33 / 25665
87	FH(2)36	(1) 12x24 (1) 24x24	(4) 20x20	(4) 20x24	(4) 20x24	(6) 20x20	(6) 20x20	(6) 20x20	(6) 20x20	(6) 20x24	(8) 20x24
		32.00 / 16000	35.00 / 17500	38.00 / 19000	41.00 / 20500	44.00 / 22000	47.00 / 23500	50.00 / 25000	53.00 / 26500	56.00 / 28000	59.00 / 29500
93	FH(2)39	(1) 12x24 (1) 24x24	(4) 20x20	(4) 20x24	(4) 20x24	(6) 20x20	(6) 20x20	(6) 20x20	(6) 20x20	(6) 20x24	(8) 20x24
		37.92 / 18960	41.00 / 20500	44.08 / 22080	47.16 / 23660	50.24 / 25240	53.32 / 26820	56.40 / 28400	59.48 / 29980	62.56 / 31560	65.64 / 33140
98	FH(2)42	(1) 12x24 (1) 24x24	(4) 20x20	(4) 20x24	(4) 20x24	(6) 20x20	(6) 20x20	(6) 20x20	(6) 20x20	(6) 20x24	(8) 20x24
		44.44 / 22220	48.00 / 24000	51.56 / 25780	55.12 / 27560	58.68 / 29340	62.24 / 31120	65.80 / 32900	69.36 / 34680	72.92 / 36440	76.48 / 38200
111	FH(2)48	(1) 12x24 (1) 24x24	(4) 20x20	(4) 20x24	(4) 20x24	(6) 20x20	(6) 20x20	(6) 20x20	(6) 20x20	(6) 20x24	(8) 20x24
		51.56 / 25780	55.12 / 27560	58.68 / 29340	62.24 / 31120	65.80 / 32900	69.36 / 34680	72.92 / 36440	76.48 / 38200	80.04 / 40000	83.60 / 41760

**LEGEND**  
UH = Cabinet Height (inches)  
UW = Cabinet Width (inches)  
FH = Coil Fin Height (inches)  
FL = Coil Fin Length (inches)  
Coil Face Area : (Qty) FH x FL  
Filter Face Area: (Qty) H x W  
Example:  
(1) 12 x 24 Filter (Qty) H x W  
Filter 6.67/3333 Face Area (Ft<sup>2</sup>)/Q (CFM)  
Coil 1.67/833 Face Area (Ft<sup>2</sup>)/Q (CFM)  
Calculations are based on 500 FPM velocity

Based on 5" unit base and 2" double wall and roof construction.

**CF Series Unit Dimensions • Flat Filter and Coil Selection Table**

**IMPERIAL**

Cabinet	UW	90	96	102	108	114	120	126	132	138
UH	Coil	FL76	FL82	FL88	FL94	FL100	FL106	FL112	FL118	FL124
28	FH15									
33	FH21									
37	FH24	(1) 12x24 (3) 24x24 14.00 / 7000 12.67 / 6335	(2) 20x24 (2) 24x24 14.67 / 7335 13.67 / 6835							
39	FH27	(1) 12x24 (3) 24x24 14.00 / 7000 14.25 / 7125	(2) 20x24 (2) 24x24 14.67 / 7335 15.38 / 7690	(4) 24x24 16.00 / 8000 16.50 / 8250						
45	FH33	(3) 12x24 (3) 20x24 16.00 / 8000 17.42 / 8710	(3) 12x24 (3) 20x24 16.00 / 8000 18.79 / 9395	(4) 12x24 (4) 20x24 21.33 / 10665 20.17 / 10085	(4) 12x24 (4) 20x24 21.33 / 10665 21.54 / 10770	(4) 12x24 (4) 20x24 21.33 / 10665 22.92 / 11460	(4) 12x24 (4) 20x24 21.33 / 10665 24.29 / 12145			
50	FH39	(8) 20x20 22.22 / 11110 20.58 / 10290	(4) 20x20 (4) 20x24 24.44 / 12220 22.21 / 11105	(8) 20x24 26.67 / 13335 23.83 / 11915	(10) 20x20 27.78 / 13890 25.46 / 12730	(6) 20x20 (4) 20x24 30.00 / 15000 27.08 / 13540	(4) 20x20 (6) 20x24 31.11 / 15555 28.71 / 14355	(12) 20x20 (6) 20x24 33.33 / 16665 30.33 / 15165	(10) 20x20 (2) 20x24 34.44 / 17220 31.96 / 15980	
53	FH42	(8) 20x20 22.22 / 11110 22.17 / 11085	(4) 20x20 (4) 20x24 24.44 / 12220 23.92 / 11960	(8) 20x24 26.67 / 13335 25.67 / 12835	(10) 20x20 27.78 / 13890 27.42 / 13710	(6) 20x20 (4) 20x24 30.00 / 15000 29.17 / 14585	(4) 20x20 (6) 20x24 31.11 / 15555 30.92 / 15460	(12) 20x20 (6) 20x24 33.33 / 16665 32.67 / 16335	(8) 20x20 (4) 20x24 35.56 / 17780 34.42 / 17210	(6) 20x20 (6) 20x24 36.67 / 18335 36.17 / 18085
57	FH45	(6) 20x24 (2) 24x24 28.00 / 14000 23.75 / 11875	(4) 20x24 (4) 24x24 29.33 / 14665 25.63 / 12815	(8) 24x24 32.00 / 16000 27.50 / 13750	(8) 20x24 (2) 24x24 34.67 / 17335 29.38 / 14690	(6) 20x24 (4) 24x24 36.00 / 18000 31.25 / 15625	(2) 20x24 (8) 24x24 38.67 / 19335 33.13 / 16565	(10) 24x24 (8) 24x24 40.00 / 20000 35.00 / 17500	(10) 20x24 (2) 24x24 41.33 / 20665 36.88 / 18440	(6) 20x24 (6) 24x24 44.00 / 22000 38.75 / 19375
60	FH48	(6) 20x24 (2) 24x24 28.00 / 14000 25.33 / 12665	(4) 20x24 (4) 24x24 29.33 / 14665 27.33 / 13665	(8) 24x24 32.00 / 16000 29.33 / 14665	(4) 20x24 (2) 24x24 34.67 / 17335 31.33 / 15665	(6) 20x24 (4) 24x24 36.00 / 18000 33.33 / 16665	(2) 20x24 (8) 24x24 38.67 / 19335 35.33 / 17665	(10) 24x24 (8) 24x24 40.00 / 20000 37.33 / 18665	(10) 20x24 (2) 24x24 41.33 / 20665 39.33 / 19665	(6) 20x24 (6) 24x24 44.00 / 22000 41.33 / 20665
66	FH54	(6) 20x24 (2) 24x24 28.00 / 14000 28.50 / 14250	(2) 20x24 (6) 24x24 30.67 / 15335 30.75 / 15375	(8) 24x24 32.00 / 16000 33.00 / 16500	(8) 20x24 (2) 24x24 34.67 / 17335 35.25 / 17625	(6) 20x24 (4) 24x24 36.00 / 18000 37.50 / 18750	(2) 20x24 (8) 24x24 38.67 / 19335 39.75 / 19875	(10) 24x24 (8) 24x24 40.00 / 20000 42.00 / 21000	(10) 20x24 (2) 24x24 41.33 / 20665 44.25 / 22125	(6) 20x24 (6) 24x24 44.00 / 22000 46.50 / 23250
73	FH(2)30	(9) 20x20 (3) 20x24 35.00 / 17500 31.67 / 15835	(3) 20x20 (9) 20x24 38.33 / 19165 34.17 / 17085	(12) 20x24 40.00 / 20000 36.67 / 18335	(12) 20x20 (3) 20x24 43.33 / 21665 39.17 / 19585	(9) 20x20 (6) 20x24 45.00 / 22500 41.67 / 20835	(3) 20x20 (12) 20x24 48.30 / 24150 44.17 / 22085	(15) 20x24 (12) 20x24 50.00 / 25000 46.67 / 23335	(12) 20x20 (6) 20x24 53.33 / 26665 49.17 / 24585	(9) 20x20 (9) 20x24 55.00 / 27500 51.67 / 25835
81	FH(2)33	(9) 20x24 (3) 24x24 42.00 / 21000 34.83 / 17415	(3) 20x24 (9) 24x24 46.00 / 23000 37.58 / 18790	(12) 24x24 48.00 / 24000 40.33 / 20165	(12) 20x24 (3) 24x24 52.00 / 26000 43.08 / 21540	(9) 20x24 (6) 24x24 54.00 / 27000 45.83 / 22915	(3) 20x24 (12) 24x24 58.00 / 29000 48.58 / 24290	(15) 24x24 (12) 24x24 60.00 / 30000 51.33 / 25665	(12) 20x24 (6) 24x24 64.00 / 32000 54.08 / 27040	(9) 20x24 (9) 24x24 66.00 / 33000 56.83 / 28415
87	FH(2)36	(12) 20x24 40.00 / 20000 38.00 / 19000	(9) 20x24 (3) 24x24 42.00 / 21000 41.00 / 20500	(6) 20x24 (6) 24x24 44.00 / 22000 44.00 / 22000	(3) 20x24 (9) 24x24 46.00 / 23000 47.00 / 23500	(9) 20x24 (6) 24x24 54.00 / 27000 50.00 / 25000	(6) 20x24 (9) 24x24 56.00 / 28000 53.00 / 26500	(15) 24x24 (12) 20x24 60.00 / 30000 56.00 / 28000	(12) 20x24 (6) 24x24 64.00 / 32000 59.00 / 29500	
93	FH(2)39	(12) 20x20 (4) 20x24 46.67 / 23335 41.17 / 20585	(4) 20x20 (12) 20x24 51.11 / 25555 44.42 / 22210	(16) 20x24 53.33 / 26665 47.67 / 23835	(16) 20x20 (4) 20x24 57.78 / 28890 50.92 / 25460	(12) 20x20 (8) 20x24 60.00 / 30000 54.17 / 27085	(4) 20x20 (16) 20x24 64.44 / 32220 57.42 / 28710	(20) 20x24 66.67 / 33335 60.67 / 30335		
98	FH(2)42	(12) 20x20 (4) 20x24 46.67 / 23335 44.33 / 22165	(4) 20x20 (12) 20x24 51.11 / 25555 47.83 / 23915	(16) 20x24 53.33 / 26665 51.33 / 25665	(16) 20x20 (4) 20x24 57.78 / 28890 54.83 / 27415	(12) 20x20 (8) 20x24 60.00 / 30000 58.33 / 29165	(4) 20x20 (16) 20x24 64.44 / 32220 61.83 / 30915			
111	FH(2)48		(4) 20x24 (12) 24x24 61.33 / 30665 54.67 / 27335	(16) 24x24 64.00 / 32000 58.67 / 29335	(16) 20x24 (4) 24x24 69.33 / 34665 62.67 / 31335					

**LEGEND**  
UH = Cabinet Height (inches)  
UW = Cabinet Width (inches)  
FH = Coil Fin Height (inches)  
FL = Coil Fin Length (inches)  
Coil Face Area : (Qty) FH x FL  
Filter Face Area: (Qty) H x W  
Example:  
(1) 12 x 24 Filter (Qty) H x W  
(3) 24 x 24 Face Area (Ft<sup>2</sup>)/Q (CFM)  
14.00 / 7000  
12.67 / 6333 Face Area (Ft<sup>2</sup>)/Q (CFM)  
Calculations are based on 500 FPM velocity

Based on 5" unit base and 2" double wall and roof construction.

**CF Series Unit Dimensions • Flat Filter and Coil Selection Table**

										<b>METRIC</b>		
<b>Cabinet</b>	<b>UW</b>	<b>762</b>	<b>914</b>	<b>1067</b>	<b>1219</b>	<b>1372</b>	<b>1524</b>	<b>1676</b>	<b>1829</b>	<b>1981</b>	<b>2134</b>	
<b>UH</b>	<b>Coil</b>	<b>FL406</b>	<b>FL559</b>	<b>FL711</b>	<b>FL864</b>	<b>FL1016</b>	<b>FL1168</b>	<b>FL1321</b>	<b>FL1473</b>	<b>FL1626</b>	<b>FL1778</b>	
711	FH381	(1) 305x610	(1) 305x610	(1) 305x610	(1) 305x610	(2) 305x610	(2) 305x610	(2) 305x610	(2) 305x610			
		0.19 / 1737	0.19 / 1737	0.19 / 1737	0.19 / 1737	0.37 / 3383	0.37 / 3383	0.37 / 3383	0.37 / 3383			
		0.16 / 1463	0.21 / 1920	0.27 / 2469	0.33 / 3018	0.39 / 3566	0.46 / 4206	0.50 / 4572	0.56 / 5121			
838	FH533	(1) 508x610	(1) 508x610	(1) 508x610	(2) 508x508	(2) 508x610	(2) 508x610	(3) 508x508	(3) 508x508	(3) 508x610	(4) 508x508	
		0.31 / 2835	0.31 / 2835	0.31 / 2835	0.52 / 4755	0.62 / 5669	0.62 / 5669	0.77 / 7041	0.77 / 7041	0.93 / 8504	1.03 / 9418	
		0.22 / 2012	0.30 / 2743	0.38 / 3475	0.46 / 4206	0.54 / 4938	0.62 / 5669	0.70 / 6401	0.79 / 7224	0.87 / 7955	0.95 / 8687	
940	FH610	(1) 610x610	(1) 305x610 (1) 508x610	(2) 508x610	(2) 610x610	(1) 305x610 (2) 508x610	(1) 305x610 (2) 610x610	(2) 508x610 (1) 610x610	(3) 610x610	(4) 508x610		
		0.37 / 3383	0.46 / 4206	0.62 / 5669	0.74 / 6767	0.81 / 7407	0.93 / 8504	0.99 / 9053	1.12 / 10241	1.24 / 11339		
		0.33 / 3018	0.43 / 3932	0.53 / 4846	0.62 / 5669	0.71 / 6492	0.81 / 7407	0.90 / 8230	0.99 / 9053	1.09 / 9967		
991	FH686	(1) 610x610	(1) 305x610 (1) 610x610	(2) 508x610	(2) 610x610	(1) 305x610 (2) 508x610	(1) 305x610 (2) 610x610	(2) 508x610 (1) 610x610	(3) 610x610	(4) 508x610		
		0.37 / 3383	0.56 / 5121	0.62 / 5669	0.74 / 6767	0.81 / 7407	0.93 / 8504	0.99 / 9053	1.12 / 10241	1.24 / 11339		
		0.38 / 3475	0.49 / 4481	0.59 / 5395	0.70 / 6401	0.80 / 7315	0.91 / 8321	1.01 / 9235	1.12 / 10241	1.22 / 11156		
1143	FH838	(1) 305x610 (1) 508x610	(1) 305x610 (1) 508x610	(2) 305x610 (2) 508x610	(2) 305x610 (2) 508x610	(2) 305x610 (2) 508x610	(2) 305x610 (2) 508x610	(2) 305x610 (2) 508x610	(3) 305x610 (3) 508x610	(3) 305x610 (3) 508x610		
		0.50 / 4572	0.50 / 4572	0.99 / 9053	0.99 / 9053	0.99 / 9053	0.99 / 9053	0.99 / 9053	0.99 / 9053	1.49 / 13625	1.49 / 13625	
		0.60 / 5486	0.72 / 6584	0.85 / 7772	0.98 / 8961	1.11 / 10150	1.24 / 11339	1.36 / 12436	1.49 / 13625			
1270	FH991	(1) 305x610 (1) 610x610	(4) 508x508	(4) 508x610	(4) 508x610	(6) 508x508	(6) 508x508	(6) 508x508	(6) 508x610	(6) 508x610		
		0.56 / 5121	1.03 / 9418	1.24 / 11339	1.24 / 11339	1.55 / 14173	1.55 / 14173	1.86 / 17008	1.86 / 17008			
		0.70 / 6401	0.86 / 7864	1.01 / 9235	1.16 / 10607	1.31 / 11979	1.46 / 13350	1.61 / 14722	1.76 / 16093			
1346	FH1067	(4) 508x508	(4) 508x610	(4) 508x610	(4) 508x610	(6) 508x508	(6) 508x508	(6) 508x508	(6) 508x610	(8) 508x508		
		1.03 / 9418	1.24 / 11339	1.24 / 11339	1.55 / 14173	1.76 / 1693	1.86 / 17008	2.07 / 18928				
		0.92 / 8412	1.09 / 9967	1.25 / 11430	1.41 / 12893	1.57 / 14356	1.74 / 15911	1.90 / 17374				
1448	FH1143	(4) 610x610	(4) 610x610	(6) 508x610	(4) 508x610 (2) 610x610	(6) 610x610	(6) 610x610	(6) 610x610	(8) 508x610			
		1.50 / 13716	1.50 / 13716	1.86 / 17008	1.98 / 18105	2.32 / 21214	2.48 / 22677					
		1.16 / 10607	1.34 / 12253	1.51 / 13807	1.69 / 15453	1.86 / 17008	2.03 / 18562					
1524	FH1219	(4) 610x610	(4) 610x610	(6) 508x610	(4) 508x610 (2) 610x610	(6) 610x610	(6) 610x610	(6) 610x610	(8) 508x610			
		1.49 / 13625	1.50 / 13716	1.86 / 17008	1.98 / 18105	2.32 / 21214	2.48 / 22677					
		1.24 / 11339	1.43 / 13076	1.61 / 14722	1.80 / 16459	1.98 / 18105	2.17 / 19842					
1676	FH1372	(4) 610x610	(6) 508x610	(4) 508x610 (2) 610x610	(6) 610x610	(8) 508x610						
		1.61 / 14722	1.86 / 17008	1.98 / 18105	2.32 / 21214	2.48 / 22677						
		1.63 / 14905	1.81 / 16551	2.02 / 18471	2.23 / 20391	2.44 / 22311						
1854	FH(2)762	(9) 508x508	(3) 508x508 (6) 508x610	(9) 508x610	(12) 508x508							
		2.33 / 21306	2.63 / 24049	2.79 / 25512	3.10 / 28346							
		2.02 / 18471	2.25 / 20574	2.48 / 22677	2.71 / 24780							
2057	FH(2)838	(3) 508x610 (6) 610x610	(9) 610x610	(12) 508x610								
		3.16 / 28895	3.35 / 30632	3.72 / 34016								
		2.47 / 22586	2.73 / 24963	2.98 / 27249								
2210	FH(2)914	(9) 610x610	(12) 508x610									
		3.35 / 30632	3.72 / 34016									
		2.98 / 27249	3.26 / 29809									
2362	FH(2)991	(16) 508x508										
		4.13 / 37765										
		3.53 / 32278										
2489	FH(2)1067	(1) 305x610	Filter (Qty) H x W									
		Filter 0.19 / 472	Face Area (Ft <sup>2</sup> )/Q (CFM)									
		Coil 0.16 / 393	Face Area (Ft <sup>2</sup> )/Q (CFM)									
2819	FH(2)1219	Calculations are based on 500 FPM velocity										

Based on 127 mm unit base and 51 mm double wall and roof construction.



**CF Series Unit Dimensions • Flat Filter and Coil Selection Table**

**METRIC**

Cabinet	UW	2286	2438	2591	2743	2896	3048	3200	3353	3505
UH	Coil	FL1930	FL2083	FL2235	FL2388	FL2540	FL2692	FL2845	FL2997	FL3150
711	FH381	<p><b>LEGEND</b>            UH = Cabinet Height (inches)            UW = Cabinet Width (inches)            FH = Coil Fin Height (inches)            FL = Coil Fin Length (inches)            Coil Face Area : (Qty) FH x FL            Filter Face Area: (Qty) H x W            Example:            Filter <b>(1) 305 x 610</b> Face Area (Ft<sup>2</sup>)/Q (CFM)                      <b>(3) 610 x 610</b> Face Area (Ft<sup>2</sup>)/Q (CFM)            Coil <b>1.30 / 3304</b> Face Area (Ft<sup>2</sup>)/Q (CFM)            Calculations are based on 500 FPM velocity</p>								
838	FH533									
940	FH610	(1) 305x610 (3) 610x610 1.30 / 11887	(2) 508x610 (2) 610x610 1.36 / 12436							
991	FH686	(1) 305x610 (3) 610x610 1.30 / 11887	(2) 508x610 (2) 610x610 1.36 / 12436	(4) 610x610 1.49 / 13625						
1143	FH838	(3) 305x610 (3) 508x610 1.49 / 13625	(3) 305x610 (3) 508x610 1.49 / 13625	(4) 305x610 (4) 508x610 1.98 / 18105	(4) 305x610 (4) 508x610 1.98 / 18105	(4) 305x610 (4) 508x610 1.98 / 18105	(4) 305x610 (4) 508x610 1.98 / 18105			
1270	FH991	(8) 508x508 2.06 / 18837	(4) 508x508 (4) 508x610 2.27 / 20757	(8) 508x610 2.48 / 22677	(10) 508x508 2.58 / 23592	(6) 508x508 (4) 508x610 2.79 / 25512	(4) 508x508 (6) 508x610 2.89 / 26426	(12) 508x508 3.10 / 28346	(10) 508x508 (2) 508x610 3.20 / 29261	
1346	FH1067	(8) 508x508 2.07 / 18928	(4) 508x508 (4) 508x610 2.27 / 20757	(8) 508x610 2.48 / 22769	(10) 508x508 2.58 / 23592	(6) 508x508 (4) 508x610 2.79 / 25512	(4) 508x508 (6) 508x610 2.89 / 26426	(12) 508x508 3.10 / 28346	(8) 508x508 (4) 508x610 3.31 / 30267	(6) 508x508 (6) 508x610 3.41 / 31181
1448	FH1143	(6) 508x610 (2) 610x610 2.60 / 23774	(4) 508x610 (4) 610x610 2.73 / 24963	(8) 610x610 2.98 / 27249	(8) 508x610 (2) 610x610 3.22 / 29444	(6) 508x610 (4) 610x610 3.35 / 30632	(2) 508x610 (8) 610x610 3.60 / 32918	(10) 610x610 3.72 / 34016	(10) 508x610 (2) 610x610 3.84 / 35113	(6) 508x610 (6) 610x610 4.10 / 37490
1524	FH1219	(6) 508x610 (2) 610x610 2.60 / 23774	(4) 508x610 (4) 610x610 2.73 / 24963	(8) 610x610 2.98 / 27249	(8) 508x610 (2) 610x610 3.22 / 29444	(6) 508x610 (4) 610x610 3.35 / 30632	(2) 508x610 (8) 610x610 3.60 / 32918	(10) 610x610 3.72 / 34016	(10) 508x610 (2) 610x610 3.84 / 35113	(6) 508x610 (6) 610x610 4.10 / 37490
1676	FH1372	(6) 508x610 (2) 610x610 2.60 / 23774	(2) 508x610 (6) 610x610 2.85 / 26060	(8) 610x610 2.98 / 27249	(8) 508x610 (2) 610x610 3.22 / 29444	(6) 508x610 (4) 610x610 3.35 / 30632	(2) 508x610 (6) 610x610 3.47 / 31730	(10) 610x610 3.72 / 34016	(10) 508x610 (2) 610x610 3.84 / 35113	(6) 508x610 (6) 610x610 4.10 / 37490
1854	FH(2)762	(9) 508x508 (3) 508x610 3.26 / 29809	(3) 508x508 (9) 508x610 3.56 / 32553	(12) 508x610 3.72 / 34016	(12) 508x508 (3) 508x610 4.03 / 36850	(9) 508x508 (6) 508x610 4.19 / 38313	(3) 508x508 (12) 508x610 4.49 / 41057	(15) 508x610 4.65 / 42520	(12) 508x508 (6) 508x610 4.96 / 45354	(9) 508x508 (9) 508x610 5.12 / 46817
2057	FH(2)838	(9) 508x610 (3) 610x610 3.91 / 35753	(3) 508x610 (9) 610x610 4.28 / 39136	(12) 610x610 4.46 / 40782	(12) 508x610 (3) 610x610 4.84 / 44257	(9) 508x610 (6) 610x610 5.02 / 45903	(3) 508x610 (12) 610x610 5.39 / 49286	(15) 610x610 5.58 / 51024	(12) 508x610 (6) 610x610 5.95 / 54407	(9) 508x610 (9) 610x610 6.14 / 56144
2210	FH(2)914	(12) 508x610 3.72 / 34016	(9) 508x610 (3) 610x610 3.91 / 35753	(6) 508x610 (6) 610x610 4.09 / 37399	(3) 508x610 (9) 610x610 4.28 / 39136	(9) 508x610 (6) 610x610 5.02 / 45902	(6) 508x610 (9) 610x610 5.21 / 47640	(15) 610x610 5.58 / 51024	(12) 508x610 (6) 610x610 5.95 / 54407	(9) 508x610 (9) 610x610 6.14 / 56144
2362	FH(2)991	(12) 508x508 (4) 508x610 4.34 / 39685	(4) 508x508 (12) 508x610 4.75 / 43434	(16) 508x610 4.96 / 45354	(16) 508x508 (4) 508x610 5.37 / 49103	(12) 508x508 (8) 508x610 5.58 / 51024	(4) 508x508 (16) 508x610 5.99 / 54773	(20) 508x610 6.20 / 56693		
2489	FH(2)1067	(12) 508x508 (4) 508x610 4.34 / 39685	(4) 508x508 (12) 508x610 4.75 / 43434	(16) 508x610 4.96 / 45354	(16) 508x508 (4) 508x610 5.37 / 49103	(12) 508x508 (8) 508x610 5.58 / 51024	(4) 508x508 (16) 508x610 5.99 / 54773			
2819	FH(2)1219		(4) 508x610 (12) 610x610 5.70 / 52121	(16) 610x610 5.95 / 54407	(16) 508x610 (4) 610x610 6.45 / 58979					

Based on 127 mm unit base and 51 mm double wall and roof construction.

**Notes:**

## F Series: Formed Frame



## Unit Selection Guidelines

### Formed Frame Construction

Thermal Corporation's **F Series** (Formed Frame) air handlers are constructed around a unitized bolted frame. The flexibility of the design lends itself to a wide range of available sizes, configurations and ease of unit maintenance.

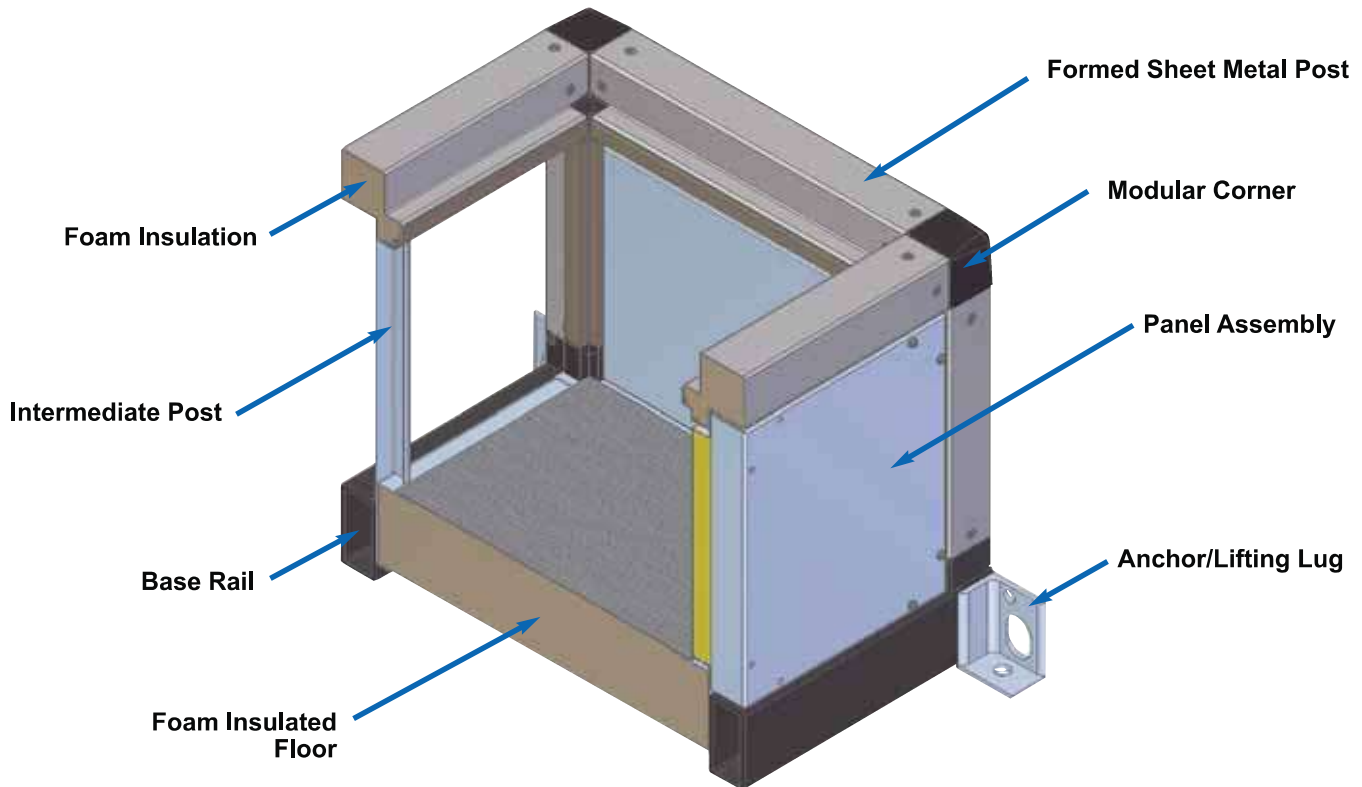

### Construction Features:

- 16 gauge (1.5 mm) galvanized steel panels with closed cell neoprene gasket around the perimeter. All panels are installed with 1/4" (6 mm) sealed fasteners. Panels can be removed without affecting the structural integrity of the bolted sheet metal frame.
- 3" (76 mm) thick walls with double wall construction.
- Structural steel fan bases are internally spring-isolated.
- AMCA-rated forward-curved (DWDI), housed airfoil (DWDI), or plenum fans (SWSI) are available.
- Full walk-on floor of galvanized steel. True "double bottom" construction with 3" (76 mm) thick form insulation.
- AHRI certified coils in 1/2" (12 mm) or 5/8" (16 mm) O.D. copper tubes. 3" (76 mm) O.D. steam distributing coils are also available upon request.
- Special third-party vendor items such as humidifiers, air blenders, evaporative coolers and integral face & bypass (IFB) coils can be factory mounted.
- Units can be designed with multiple fans for lower profiles or redundant.
- Full selection of air filters to meet indoor air quality standards.
- Outdoor units can be provided with roof curbs.

### Shipping

Flatbed trailers are used to ship air handling units that are less than or equal to 108" (2743 mm) tall and 102" (2591 mm) wide. Units less than or equal to 144" (3658 mm) wide and 312" (7925 mm) in direction of airflow can be built and shipped as one piece. Demounts should be added when using these dimensions. As long as there are no shipping limitations, multiple section air handlers ship as a single factory assembled unit. Modular sections may then be demounted in the field by others. Contact factory for units which exceed 133" (3378 mm) tall or 138" (3505 mm) wide.

### Design Flexibility:

- Units are customized to your particular application.
- Wide ranges of unit sizes are available based on CFM (m<sup>3</sup>/hr.) requirement.
- Units can be designed for indoor or outdoor applications. Only indoor units are available in vertical configurations.



# Unit Selection Guidelines

## Formed Frame Construction

### All Dimensions based on 3" (76 mm) thick casing walls

#### Getting Started

The following information must be known in order to properly design a Thermal custom air handling unit:

1. Total Unit Supply Airflow (CFM / m<sup>3</sup>/hr.)
2. Total Static Pressure (in. w.g. / Pa)
3. Unit Configuration
4. Coil Conditions
5. Filtration Requirements

If you are only provided with the external static pressure (ESP) use the quick pressure drop tables on the following pages to establish the total static pressure (TSP) of the unit.

#### Step 1:

Using a copy of the selection template provided at the back of the selection catalog, select whether the unit is indoor or outdoor. Next, enter the CFM (m<sup>3</sup>/hr.) and TSP of each fan.

#### Step 2:

Now that you have established the TSP and CFM (m<sup>3</sup>/hr.) use the fan selection software to pick the proper fan(s). Make sure to record the type of fan(s), required horsepower(s), and motor frame size(s).

#### Fan Type Guidelines

The fans that produce the highest mechanical efficiency are DWDI housed airfoil. However, when you have a blow through application, un-ducted discharge system effect losses often offset their efficiency. While DWDI housed airfoil fans can be used in applications greater than 4" w.g. (995 Pa), DWDI forward curved fans offer quiet operation for return air applications and static pressures less than 4" w.g. (995 Pa).

SWSI Plenum fans pressurize the entire plenum and generate very little velocity pressure, making them ideal for blow through applications and multiple supply air duct openings requirement. While most manufacturers use 8 or 9 bladed plenum fan wheels, Thermal Corporation uses 12 bladed fan wheels.

#### Step 3:

Record the minimum cabinet height and length required for your fan from the fan reference tables. Motor position and size determine the minimum cabinet width.

#### Step 4:

Now turn to the unit selection table. Locate the selection that meets your airflow requirements using your total airflow. Move right and down to any other block that will work if cabinet height and width is less than the minimum required for the fan. Enter the cabinet size in the space provided on the selection template.

#### Step 5:

From the unit selection grid, enter the coil finned height and width. Proceed to the component section and select the required modules.

**Note:** Alternate unit sizes are available. Use the following guidelines to help figure out available fin height and length for a given unit height and width:

#### Fin Height

1. Standard units with 1 coil high, allow fin height + 11" (279 mm)
2. Standard units with 2 coils high, allow fin height + 13" (330 mm)
3. Standard units with 3 coils high, allow fin height + 15" (381 mm)

#### Fin Length

1. Standard units with 1 coil wide, allow fin length + 14" (356 mm)
2. Outdoor units with a 12" (305 mm) internal pipe chase, allow total fin length + 30" (762 mm)

#### Miscellaneous Options

1. Cleanable return bends, allow fin length + 15" (381 mm)
2. 4" (102 mm) connections, allow fin height + 12" (305 mm) and fin length + 16" (406 mm)

**Note:** These guidelines do not include outdoor roof pitch and are based on 4" (106 mm) unit base and up to 3" (76 mm) coil connections.

F Series Unit Dimensions • Flat Filter and Coil Selection Table

**IMPERIAL**

Cabinet	UW	32	38	44	50	56	62	68	74	80	86
UH	Coil	FL16	FL22	FL28	FL34	FL40	FL46	FL52	FL58	FL64	FL70
29	FH15	(1) 12x24	(1) 12x24	(1) 12x24	(1) 12x24	(2) 12x24	(2) 12x24	(2) 12x24	(2) 12x24		
		2.00 / 1000	2.00 / 1000	2.00 / 1000	2.00 / 1000	4.00 / 2000	4.00 / 2000	4.00 / 2000	4.00 / 2000		
34	FH21	(1) 20x24	(1) 20x24	(1) 20x24	(2) 20x20	(2) 20x24	(2) 20x24	(3) 20x20	(3) 20x20	(3) 20x24	(4) 20x20
		3.33 / 1665	3.33 / 1665	3.33 / 1665	5.56 / 2780	6.67 / 3335	6.67 / 3333	8.33 / 4165	8.33 / 4165	10.00 / 5000	11.11 / 5555
38	FH24	(1) 24x24	(1) 12x24 (1) 20x24	(2) 20x24	(2) 24x24	(1) 12x24 (2) 20x24	(1) 12x24 (2) 24x24	(2) 20x24 (1) 24x24	(3) 24x24	(4) 20x24	
		4.00 / 2000	5.33 / 2665	6.67 / 3335	8.00 / 4000	8.67 / 4335	10.00 / 5000	10.67 / 5335	12.00 / 6000	13.33 / 6665	
40	FH27	(1) 24x24	(1) 12x24 (1) 24x24	(2) 20x24	(2) 24x24	(1) 12x24 (2) 20x24	(1) 12x24 (2) 24x24	(2) 20x24 (1) 24x24	(3) 24x24	(4) 20x24	
		2.00 / 1000	6.00 / 3000	6.67 / 3335	8.00 / 4000	8.67 / 4335	10.00 / 5000	10.67 / 5335	12.00 / 6000	13.33 / 6665	
46	FH33	(1) 12x24 (1) 20x24	(1) 12x24 (1) 20x24	(2) 12x24 (2) 20x24	(2) 12x24 (2) 20x24	(2) 12x24 (2) 20x24	(2) 12x24 (2) 20x24	(2) 12x24 (2) 20x24	(3) 12x24 (3) 20x24	(3) 12x24 (3) 20x24	(3) 12x24 (3) 20x24
		5.33 / 2665	5.33 / 2665	10.67 / 5335	10.67 / 5335	10.67 / 5335	10.67 / 5335	10.67 / 5335	16.00 / 8000	16.00 / 8000	
51	FH39	(1) 12x24 (1) 24x24	(4) 20x20	(4) 20x24	(4) 20x24	(6) 20x20	(6) 20x20	(6) 20x24	(6) 20x24	(6) 20x24	(6) 20x24
		6.00 / 3000	11.11 / 5555	13.33 / 6665	13.33 / 6665	16.67 / 8335	16.67 / 8335	20.00 / 10000	20.00 / 10000		
54	FH42	(1) 12x24 (1) 24x24	(4) 20x20	(4) 20x24	(4) 20x24	(6) 20x20	(6) 20x20	(6) 20x24	(6) 20x24	(8) 20x20	
		7.58 / 3790	9.21 / 4605	10.83 / 5415	12.46 / 6230	14.08 / 7040	15.71 / 7855	17.33 / 8665	18.96 / 9480		
58	FH45	(4) 20x20	(4) 20x24	(4) 20x24	(4) 20x24	(6) 20x20	(6) 20x20	(6) 20x24	(6) 20x24	(8) 20x20	
		11.11 / 5555	13.33 / 6665	13.33 / 6665	16.67 / 8335	18.89 / 9445	20.00 / 10000	22.22 / 11110			
61	FH48	(4) 24x24	(4) 24x24	(6) 20x24	(4) 24x24	(6) 20x24	(4) 24x24	(6) 24x24	(6) 24x24	(8) 20x24	
		16.00 / 8000	16.00 / 8000	20.00 / 10000	21.33 / 10665	24.00 / 12000	26.66 / 13330				
67	FH54	(4) 24x24	(4) 24x24	(6) 20x24	(4) 24x24	(6) 20x24	(4) 24x24	(6) 24x24	(6) 24x24	(8) 20x24	
		16.00 / 8000	16.00 / 8000	20.00 / 10000	21.33 / 10665	24.00 / 12000	26.67 / 13335				
74	FH(2)30	(9) 20x20	(3) 20x20 (6) 20x24	(9) 20x24	(12) 20x20						
		25.00 / 12500	28.33 / 14165	30.00 / 15000	33.33 / 16665						
82	FH(2)33	(9) 20x20	(9) 24x24	(12) 20x24							
		34.00 / 17000	36.00 / 18000	40.00 / 20000							
88	FH(2)36	(9) 24x24	(12) 20x24								
		36.00 / 18000	40.00 / 20000								
94	FH(2)39	(32.00 / 16000)	(35.00 / 17500)	(16) 20x20							
		37.92 / 18960									
99	FH(2)42	(1) 12 x 24	Filter (Qty) H x W								
		6.67/3333	Face Area (Ft <sup>2</sup> )/Q (CFM)								
112	FH(2)48	1.67/833	Face Area (Ft <sup>2</sup> )/Q (CFM)								
			Calculations are based on 500 FPM velocity								

Based on 4" unit base and 3" double wall and roof construction.

**F Series Unit Dimensions • Flat Filter and Coil Selection Table**

**IMPERIAL**

Cabinet	UW	92	98	104	110	116	122	128	134	140						
UH	Coil	FL76	FL82	FL88	FL94	FL100	FL106	FL112	FL118	FL124						
29	FH15	<div style="border: 1px solid black; padding: 5px;"> <p align="center"><b>LEGEND</b></p> <p>UH = Cabinet Height (inches)            UW = Cabinet Width (inches)            FH = Coil Fin Height (inches)            FL = Coil Fin Length (inches)            Coil Face Area : (Qty) FH x FL            Filter Face Area: (Qty) H x W            Example:</p> <table border="1" style="margin-left: auto; margin-right: auto;"> <tr> <td style="background-color: #ffff00;">(1) 12 x 24</td> <td>Filter (Qty) H x W</td> </tr> <tr> <td style="background-color: #ffff00;">(3) 24 x 24</td> <td>Face Area (Ft<sup>2</sup>)/Q (CFM)</td> </tr> <tr> <td style="background-color: #ffff00;">14.00 / 7000</td> <td>Face Area (Ft<sup>2</sup>)/Q (CFM)</td> </tr> </table> <p>Filter <span style="background-color: #ffff00;">12.67/6333</span>            Coil <span style="background-color: #ffff00;">14.00/7000</span>  <i>Calculations are based on 500 FPM velocity</i></p> </div>									(1) 12 x 24	Filter (Qty) H x W	(3) 24 x 24	Face Area (Ft <sup>2</sup> )/Q (CFM)	14.00 / 7000	Face Area (Ft <sup>2</sup> )/Q (CFM)
(1) 12 x 24	Filter (Qty) H x W															
(3) 24 x 24	Face Area (Ft <sup>2</sup> )/Q (CFM)															
14.00 / 7000	Face Area (Ft <sup>2</sup> )/Q (CFM)															
34	FH21															
38	FH24	(1) 12x24 (3) 24x24 14.00 / 7000 12.67 / 6335	(2) 20x24 (2) 24x24 14.67 / 7335													
40	FH27	(1) 12x24 (3) 24x24 14.00 / 7000	(2) 20x24 (2) 24x24 14.67 / 7335	(4) 24x24 16.00 / 8000												
46	FH33	(3) 12x24 (3) 20x24 16.00 / 8000	(3) 12x24 (3) 20x24 16.00 / 8000	(4) 12x24 (4) 20x24 21.33 / 10665	(4) 12x24 (4) 20x24 21.33 / 10665	(4) 12x24 (4) 20x24 21.33 / 10665	(4) 12x24 (4) 20x24 21.33 / 10665									
51	FH39	(8) 20x20 22.22 / 11110 20.58 / 10290	(4) 20x20 (4) 20x24 24.44 / 12220 22.21 / 11105	(8) 20x24 26.67 / 13335 23.83 / 11915	(10) 20x20 27.78 / 13890 25.46 / 12730	(6) 20x20 (4) 20x24 30.00 / 15000 27.08 / 13540	(4) 20x20 (6) 20x24 31.11 / 15555 28.71 / 14355	(12) 20x20 33.33 / 16665 30.33 / 15165	(10) 20x20 (2) 20x24 34.44 / 17220 31.96 / 15980							
54	FH42	(8) 20x20 22.22 / 11110 22.17 / 11085	(4) 20x20 (4) 20x24 24.44 / 12220 23.92 / 11960	(8) 20x24 26.67 / 13335 25.67 / 12835	(10) 20x20 27.78 / 13890 27.42 / 13710	(6) 20x20 (4) 20x24 30.00 / 15000 29.17 / 14585	(4) 20x20 (6) 20x24 31.11 / 15555 30.92 / 15460	(12) 20x20 33.33 / 16665 32.67 / 16335	(8) 20x20 (4) 20x24 35.56 / 17780 34.42 / 17210	(6) 20x20 (6) 20x24 36.67 / 18335 36.17 / 18085						
58	FH45	(6) 20x24 (2) 24x24 28.00 / 14000 23.75 / 11875	(4) 20x24 (4) 24x24 29.33 / 14665 25.63 / 12815	(8) 24x24 32.00 / 16000 27.50 / 13750	(8) 20x24 (2) 24x24 34.67 / 17335 29.38 / 14690	(6) 20x24 (4) 24x24 36.00 / 18000 31.25 / 15625	(2) 20x24 (8) 24x24 38.67 / 19335 33.13 / 16565	(10) 24x24 40.00 / 20000 35.00 / 17500	(10) 20x24 (2) 24x24 41.33 / 20665 36.88 / 18440	(6) 20x24 (6) 24x24 44.00 / 22000 38.75 / 19375						
61	FH48	(6) 20x24 (2) 24x24 28.00 / 14000 25.33 / 12665	(4) 20x24 (4) 24x24 29.33 / 14665 27.33 / 13665	(8) 24x24 32.00 / 16000 29.33 / 14665	(4) 20x24 (2) 24x24 34.67 / 17335 31.33 / 15665	(6) 20x24 (4) 24x24 36.00 / 18000 33.33 / 16665	(2) 20x24 (8) 24x24 38.67 / 19335 35.33 / 17665	(10) 24x24 40.00 / 20000 37.33 / 18665	(10) 20x24 (2) 24x24 41.33 / 20665 39.33 / 19665	(6) 20x24 (6) 24x24 44.00 / 22000 41.33 / 20665						
67	FH54	(6) 20x24 (2) 24x24 28.00 / 14000 28.50 / 14250	(2) 20x24 (6) 24x24 30.67 / 15335 30.75 / 15375	(8) 24x24 32.00 / 16000 33.00 / 16500	(8) 20x24 (2) 24x24 34.67 / 17335 35.25 / 17625	(6) 20x24 (4) 24x24 36.00 / 18000 37.50 / 18750	(2) 20x24 (8) 24x24 38.67 / 19335 39.75 / 19875	(10) 24x24 40.00 / 20000 42.00 / 21000	(10) 20x24 (2) 24x24 41.33 / 20665 44.25 / 22125	(6) 20x24 (6) 24x24 44.00 / 22000 46.50 / 23250						
74	FH(2)30	(9) 20x20 (3) 20x24 35.00 / 17500 31.67 / 15835	(3) 20x20 (9) 20x24 38.33 / 19165 34.17 / 17085	(12) 20x24 40.00 / 20000 36.67 / 18335	(12) 20x20 (3) 20x24 43.33 / 21665 39.17 / 19585	(9) 20x20 (6) 20x24 45.00 / 22500 41.67 / 20835	(3) 20x20 (12) 20x24 48.30 / 24150 44.17 / 22085	(15) 20x24 50.00 / 25000 46.67 / 23335	(12) 20x20 (6) 20x24 53.33 / 26665 49.17 / 24585	(9) 20x20 (9) 20x24 55.00 / 27500 51.67 / 25835						
82	FH(2)33	(9) 20x24 (3) 24x24 42.00 / 21000 34.83 / 17415	(3) 20x24 (9) 24x24 46.00 / 23000 37.58 / 18790	(12) 24x24 48.00 / 24000 40.33 / 20165	(12) 20x24 (3) 24x24 52.00 / 26000 43.08 / 21540	(9) 20x24 (6) 24x24 54.00 / 27000 45.83 / 22915	(3) 20x24 (12) 24x24 58.00 / 29000 48.58 / 24290	(15) 24x24 60.00 / 30000 51.33 / 25665	(12) 20x24 (6) 24x24 64.00 / 32000 54.08 / 27040	(9) 20x24 (9) 24x24 66.00 / 33000 56.83 / 28415						
88	FH(2)36	(12) 20x24 40.00 / 20000 38.00 / 19000	(9) 20x24 (3) 24x24 42.00 / 21000 41.00 / 20500	(6) 20x24 (6) 24x24 44.00 / 22000 44.00 / 22000	(3) 20x24 (9) 24x24 46.00 / 23000 47.00 / 23500	(9) 20x24 (6) 24x24 54.00 / 27000 50.00 / 25000	(6) 20x24 (9) 24x24 56.00 / 28000 53.00 / 26500	(15) 24x24 60.00 / 30000 56.00 / 28000	(12) 20x24 (6) 24x24 64.00 / 32000 59.00 / 29500							
94	FH(2)39	(12) 20x20 (4) 20x24 46.67 / 23335 41.17 / 20585	(4) 20x20 (12) 20x24 51.11 / 25555 44.42 / 22210	(16) 20x24 53.33 / 26665 47.67 / 23835	(16) 20x20 (4) 20x24 57.78 / 28890 50.92 / 25460	(12) 20x20 (8) 20x24 60.00 / 30000 54.17 / 27085	(4) 20x20 (16) 20x24 64.44 / 32220 57.42 / 28710	(20) 20x24 66.67 / 33335 60.67 / 30335								
99	FH(2)42	(12) 20x20 (4) 20x24 46.67 / 23335 44.33 / 22165	(4) 20x20 (12) 20x24 51.11 / 25555 47.83 / 23915	(16) 20x24 53.33 / 26665 51.33 / 25665	(16) 20x20 (4) 20x24 57.78 / 28890 54.83 / 27415	(12) 20x20 (8) 20x24 60.00 / 30000 58.33 / 29165	(4) 20x20 (16) 20x24 64.44 / 32220 61.83 / 30915									
112	FH(2)48		(4) 20x24 (12) 24x24 61.33 / 30665 54.67 / 27335	(16) 24x24 64.00 / 32000 58.67 / 29335	(16) 20x24 (4) 24x24 69.33 / 34665 62.67 / 31335											

Based on 4" unit base and 3" double wall and roof construction.

**F Series Unit Dimensions • Flat Filter and Coil Selection Table**

**METRIC**

Cabinet	UW	813	965	1118	1270	1422	1575	1727	1880	2032	2184
UH	Coil	FL406	FL559	FL711	FL864	FL1016	FL1168	FL1321	FL1473	FL1626	FL1778
737	FH381	(1) 305x610	(1) 305x610	(1) 305x610	(1) 305x610	(2) 305x610	(2) 305x610	(2) 305x610	(2) 305x610		
		0.19 / 1737	0.19 / 1737	0.19 / 1737	0.19 / 1737	0.37 / 3383	0.37 / 3383	0.37 / 3383	0.37 / 3383		
864	FH533	(1) 508x610	(1) 508x610	(1) 508x610	(2) 508x508	(2) 508x610	(2) 508x610	(3) 508x508	(3) 508x508	(3) 508x610	(4) 508x508
		0.31 / 2835	0.31 / 2835	0.31 / 2835	0.52 / 4755	0.62 / 5669	0.62 / 5669	0.77 / 7041	0.77 / 7041	0.93 / 8504	1.03 / 9418
965	FH610	(1) 610x610	(1) 305x610	(2) 508x610	(2) 610x610	(1) 305x610	(1) 305x610	(2) 508x610	(2) 508x610	(3) 610x610	(4) 508x610
		0.37 / 3383	0.46 / 4206	0.62 / 5669	0.74 / 6767	0.81 / 7407	0.81 / 7407	0.93 / 8504	0.99 / 9053	1.12 / 10241	1.24 / 11339
1016	FH686	(1) 610x610	(1) 305x610	(2) 508x610	(2) 610x610	(1) 305x610	(1) 305x610	(2) 508x610	(2) 508x610	(3) 610x610	(4) 508x610
		0.37 / 3383	0.56 / 5121	0.62 / 5669	0.74 / 6767	0.81 / 7407	0.81 / 7407	0.93 / 8504	0.99 / 9053	1.12 / 10241	1.24 / 11339
1168	FH838	(1) 610x610	(1) 305x610	(2) 508x610	(2) 610x610	(1) 305x610	(1) 305x610	(2) 508x610	(2) 508x610	(3) 610x610	(4) 508x610
		0.38 / 3475	0.49 / 4481	0.59 / 5395	0.70 / 6401	0.80 / 7315	0.91 / 8321	1.01 / 9235	1.12 / 10241	1.22 / 11156	
1295	FH991	(1) 305x610	(1) 305x610	(2) 305x610	(2) 305x610	(2) 305x610	(2) 305x610	(2) 305x610	(2) 305x610	(3) 305x610	(3) 305x610
		0.56 / 5121	1.03 / 9418	1.24 / 11339	1.24 / 11339	1.55 / 14173	1.55 / 14173	1.86 / 17008	1.86 / 17008		
1372	FH1067	(1) 610x610	(4) 508x508	(4) 508x610	(4) 508x610	(4) 508x610	(6) 508x508	(6) 508x508	(6) 508x508	(6) 508x610	(6) 508x610
		0.70 / 6401	0.86 / 7864	1.01 / 9235	1.16 / 10607	1.31 / 11979	1.46 / 13350	1.61 / 14722	1.76 / 16093		
1473	FH1143	(4) 508x508	(4) 508x610	(4) 508x610	(4) 508x610	(6) 508x508	(6) 508x508	(2) 508x508	(6) 508x610	(8) 508x508	(8) 508x508
		1.03 / 9418	1.24 / 11339	1.24 / 11339	1.24 / 11339	1.55 / 14173	1.76 / 1693	1.86 / 17008	2.07 / 18928		
1549	FH1219	(4) 610x610	(4) 610x610	(6) 508x610	(4) 508x610	(6) 508x610	(4) 508x610	(6) 508x610	(6) 610x610	(8) 508x610	(8) 508x610
		1.16 / 10607	1.34 / 12253	1.51 / 13807	1.69 / 15453	1.86 / 17008	1.98 / 18105	2.32 / 21214	2.48 / 22677		
1702	FH1372	(4) 610x610	(4) 610x610	(6) 508x610	(4) 508x610	(6) 508x610	(4) 508x610	(6) 508x610	(6) 610x610	(8) 508x610	(8) 508x610
		1.49 / 13625	1.50 / 13716	1.86 / 17008	1.98 / 18105	2.32 / 21214	2.48 / 22677				
1880	FH(2)762	(4) 610x610	(6) 508x610	(4) 508x610	(6) 508x610	(4) 508x610	(6) 508x610	(6) 610x610	(8) 508x610	(8) 508x610	(8) 508x610
		1.61 / 14722	1.86 / 17008	1.98 / 18105	2.32 / 21214	2.48 / 22677					
2083	FH(2)838	(9) 508x508	(3) 508x508	(9) 508x610	(12) 508x508	(9) 508x508	(3) 508x508	(9) 508x610	(12) 508x508		
		2.33 / 21306	2.63 / 24049	2.79 / 25512	3.10 / 28346	2.47 / 22586	2.73 / 24963	2.98 / 27249			
2235	FH(2)914	(3) 508x610	(9) 610x610	(12) 508x610							
		3.16 / 28895	3.35 / 30632	3.72 / 34016							
2388	FH(2)991	(9) 610x610	(12) 508x610								
		2.98 / 27249	3.26 / 29809								
2515	FH(2)1067	(16) 508x508									
		4.13 / 37765	3.53 / 32278								
2845	FH(2)1219										

**LEGEND**  
UH = Cabinet Height (inches)  
UW = Cabinet Width (inches)  
FH = Coil Fin Height (inches)  
FL = Coil Fin Length (inches)  
Coil Face Area : (Qty) FH x FL  
Filter Face Area: (Qty) H x W  
Example:  
**(1) 305x610** Filter (Qty) H x W  
Filter **0.19/472** Face Area (Ft<sup>2</sup>)/Q (CFM)  
Coil **0.16/393** Face Area (Ft<sup>2</sup>)/Q (CFM)  
Calculations are based on 500 FPM velocity

Based on 102 mm unit base and 76 mm double wall and roof construction.



**F Series Unit Dimensions • Flat Filter and Coil Selection Table**

**METRIC**

Cabinet	UW	2337	2489	2642	2794	2946	3099	3251	3404	3556
UH	Coil	FL1930	FL2083	FL2235	FL2388	FL2540	FL2692	FL2845	FL2997	FL3150
737	FH381	<p><b>LEGEND</b>            UH = Cabinet Height (inches)            UW = Cabinet Width (inches)            FH = Coil Fin Height (inches)            FL = Coil Fin Length (inches)            Coil Face Area : (Qty) FH x FL            Filter Face Area: (Qty) H x W            Example:            Filter <b>(1) 305 x 610</b> Face Area (Ft<sup>2</sup>)/Q (CFM)                      <b>(3) 610 x 610</b> Face Area (Ft<sup>2</sup>)/Q (CFM)            Coil <b>1.30 / 3304</b> Face Area (Ft<sup>2</sup>)/Q (CFM)            Calculations are based on 500 FPM velocity</p>								
864	FH533									
965	FH610	(1) 305x610 3.30 / 11887 1.33 / 10790	(2) 508x610 (2) 610x610 1.36 / 12436 1.27 / 11613							
1016	FH686	(1) 305x610 (3) 610x610 1.30 / 11887 1.33 / 12162	(2) 508x610 (2) 610x610 1.36 / 12436 1.43 / 13076	(4) 610x610 1.49 / 13625						
1168	FH838	(3) 305x610 (3) 508x610 1.49 / 13625 1.62 / 14813	(3) 305x610 (3) 508x610 1.49 / 13625 1.75 / 16002	(4) 305x610 (4) 508x610 1.98 / 18105 1.88 / 17191	(4) 305x610 (4) 508x610 1.98 / 18105 2.00 / 18288	(4) 305x610 (4) 508x610 1.98 / 18105 2.13 / 19477	(4) 305x610 (4) 508x610 1.98 / 18105 2.26 / 20665			
1295	FH991	(8) 508x508 2.06 / 18837 1.91 / 17465	(4) 508x508 (4) 508x610 2.27 / 20757 2.07 / 18928	(8) 508x610 2.48 / 22677	(10) 508x508 2.58 / 23592 2.22 / 20300	(6) 508x508 (4) 508x610 2.79 / 25512 2.37 / 21671	(4) 508x508 (6) 508x610 2.89 / 26426 2.52 / 23043	(12) 508x508 3.10 / 28346 2.67 / 24414	(10) 508x508 (2) 508x610 3.31 / 30267 2.82 / 25786	(2) 508x610 3.41 / 31181 2.97 / 27158
1372	FH1067	(8) 508x508 2.07 / 18928 2.06 / 18837	(4) 508x508 (4) 508x610 2.27 / 20757 2.22 / 20300	(8) 508x610 2.48 / 22769 2.39 / 21854	(10) 508x508 2.58 / 23592 2.55 / 23317	(6) 508x508 (4) 508x610 2.79 / 25512 2.71 / 24780	(4) 508x508 (6) 508x610 2.89 / 26426 2.88 / 26335	(12) 508x508 3.10 / 28346 3.04 / 27798	(8) 508x508 (4) 508x610 3.31 / 30267 3.20 / 29261	(6) 508x610 (6) 508x610 3.41 / 31181 3.26 / 29809
1473	FH1143	(6) 508x610 (2) 610x610 2.60 / 23774 2.21 / 20208	(4) 508x610 (4) 610x610 2.73 / 24963 2.38 / 21763	(8) 610x610 2.98 / 27249 2.56 / 23409	(8) 508x610 (2) 610x610 3.22 / 29444 2.73 / 24963	(6) 508x610 (4) 610x610 3.35 / 30632 2.91 / 26609	(2) 508x610 (8) 610x610 3.60 / 32918 3.08 / 28164	(10) 610x610 3.72 / 34016 3.26 / 29809	(10) 508x610 (2) 610x610 3.84 / 35113 3.43 / 31364	(6) 508x610 (6) 610x610 4.10 / 37490 3.60 / 32918
1549	FH1219	(6) 508x610 (2) 610x610 2.60 / 23774 2.36 / 21580	(4) 508x610 (4) 610x610 2.73 / 24963 2.54 / 23226	(8) 610x610 2.98 / 27249 2.73 / 24963	(8) 508x610 (2) 610x610 3.22 / 29444 2.91 / 26609	(6) 508x610 (4) 610x610 3.35 / 30632 3.10 / 28346	(2) 508x610 (8) 610x610 3.60 / 32918 3.29 / 30084	(10) 610x610 3.72 / 34016 3.47 / 31730	(10) 508x610 (2) 610x610 3.84 / 35113 3.66 / 33467	(6) 508x610 (6) 610x610 4.10 / 37490 3.84 / 35113
1702	FH1372	(6) 508x610 (2) 610x610 2.60 / 23774 2.65 / 24232	(2) 508x610 (6) 610x610 2.85 / 26060 2.86 / 26152	(8) 610x610 2.98 / 27249 3.10 / 28346	(8) 508x610 (2) 610x610 3.22 / 29444 3.28 / 29992	(6) 508x610 (4) 610x610 3.35 / 30632 3.49 / 31913	(4) 508x610 (6) 610x610 3.47 / 31730 3.70 / 33833	(10) 610x610 3.72 / 34016 3.91 / 35753	(10) 508x610 (2) 610x610 3.84 / 35113 4.12 / 37673	(6) 508x610 (6) 610x610 4.10 / 37490 4.32 / 39502
1880	FH(2)762	(9) 508x508 (3) 508x610 3.26 / 29809 2.95 / 26975	(3) 508x508 (9) 508x610 3.56 / 32553 3.18 / 29078	(12) 508x610 3.72 / 34016 3.41 / 31181	(12) 508x508 (3) 508x610 4.03 / 36850 3.64 / 33284	(9) 508x508 (6) 508x610 4.19 / 38313 3.88 / 35479	(3) 508x508 (12) 508x610 4.49 / 41057 4.11 / 37582	(15) 508x610 4.65 / 42520 4.34 / 39685	(12) 508x508 (6) 508x610 4.96 / 45354 4.57 / 41788	(9) 508x508 (9) 508x610 5.12 / 46817 4.81 / 43983
2083	FH(2)838	(9) 508x610 (3) 610x610 3.91 / 35753 3.24 / 29627	(3) 508x610 (9) 610x610 4.28 / 39136 3.49 / 31913	(12) 610x610 4.46 / 40782 3.75 / 34290	(12) 508x610 (3) 610x610 4.84 / 44257 4.01 / 36667	(9) 508x610 (6) 610x610 5.02 / 45903 4.26 / 38953	(3) 508x610 (12) 610x610 5.39 / 49286 4.52 / 41331	(15) 610x610 5.58 / 51024 4.77 / 43617	(12) 508x610 (6) 610x610 5.95 / 54407 5.03 / 45994	(9) 508x610 (9) 610x610 6.14 / 56144 5.29 / 48372
2235	FH(2)914	(12) 508x610 3.72 / 34016 3.53 / 32278	(9) 508x610 (3) 610x610 3.91 / 35753 3.81 / 34839	(6) 508x610 (6) 610x610 4.09 / 37399 4.10 / 37490	(3) 508x610 (9) 610x610 4.28 / 39136 4.37 / 39959	(9) 508x610 (6) 610x610 5.02 / 45902 4.65 / 42520	(6) 508x610 (9) 610x610 5.21 / 47640 4.93 / 45080	(15) 610x610 5.58 / 51024 5.21 / 47640	(12) 508x610 (6) 610x610 5.95 / 54407 5.49 / 50201	
2388	FH(2)991	(12) 508x508 (4) 508x610 4.34 / 39685 3.83 / 35022	(4) 508x508 (12) 508x610 4.75 / 43434 4.13 / 37765	(16) 508x610 4.96 / 45354 4.43 / 40508	(16) 508x508 (4) 508x610 5.37 / 49103 4.74 / 43343	(12) 508x508 (8) 508x610 5.58 / 51024 5.04 / 46086	(4) 508x508 (16) 508x610 5.99 / 54773 5.34 / 48829	(20) 508x610 6.20 / 56693 5.64 / 51572		
2515	FH(2)1067	(12) 508x508 (4) 508x610 4.34 / 39685 4.12 / 37673	(4) 508x508 (12) 508x610 4.75 / 43434 4.45 / 40691	(16) 508x610 4.96 / 45354 4.77 / 43617	(16) 508x508 (4) 508x610 5.37 / 49103 5.10 / 46634	(12) 508x508 (8) 508x610 5.58 / 51024 5.42 / 49560	(4) 508x508 (16) 508x610 5.99 / 54773 5.75 / 52578			
2845	FH(2)1219		(4) 508x610 (12) 610x610 5.70 / 52121 5.08 / 46452	(16) 610x610 5.95 / 54407 5.47 / 50018	(16) 508x610 (4) 610x610 6.45 / 58979 5.83 / 53310					

Based on 102 mm unit base and 76 mm double wall and roof construction.

**Notes:**

# TS Series: Foam Panel



## Unit Selection Guidelines

### Foam Panel Construction

Thermal Corporation's T<sup>2</sup> (TS) Series (Foam Panel) style of air handlers are constructed around a unitized aluminum frame and "true thermal break" foam panel. The flexibility of the foam panel design allows it to be shipped with minimal fasteners and completely knocked down for field assembly. This feature allows for retrofit applications where maximum section size is an issue.

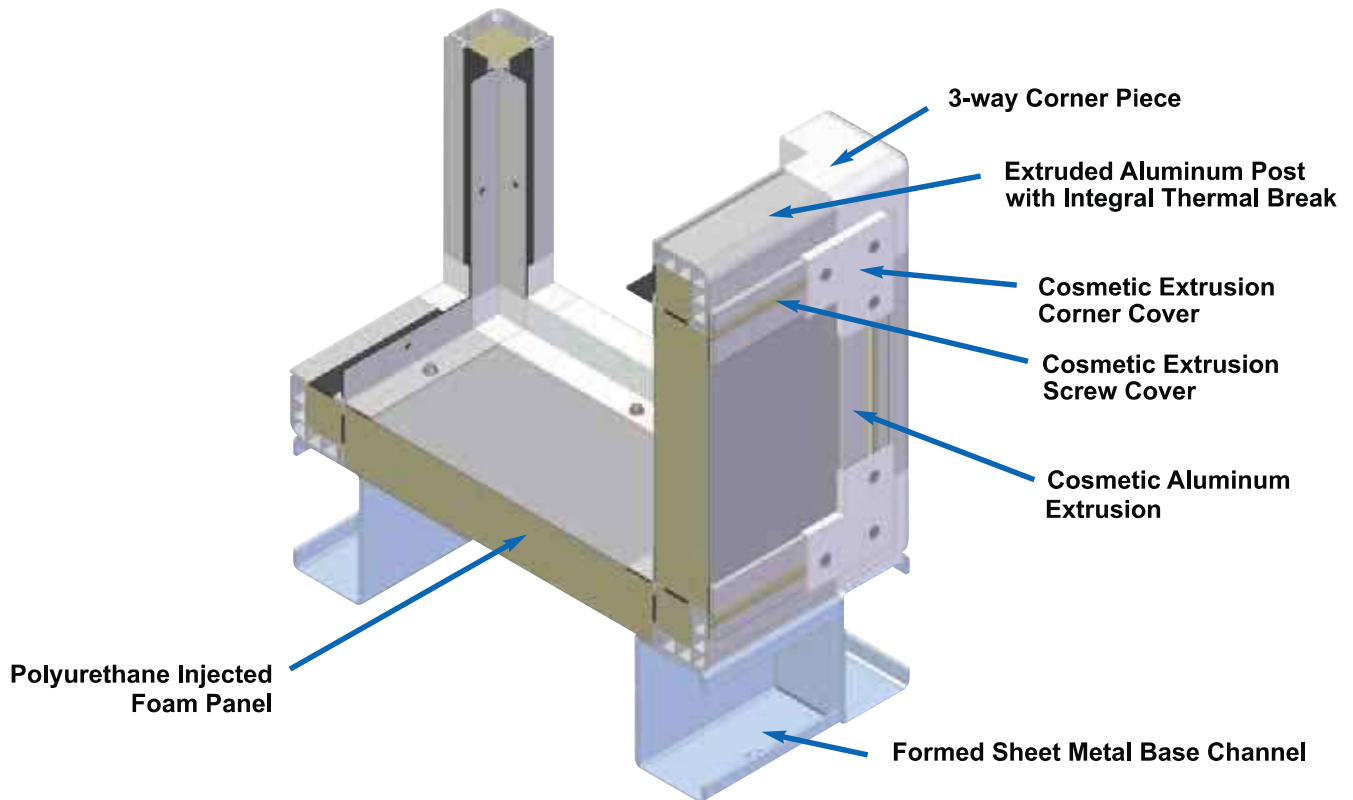

### Construction Features:

- 24 gauge (0.6 mm) double wall pre-painted steel material with Polyurethane high thermal insulation and closed cell neoprene gasket around the frame perimeter. All panels are installed with 1/4" (6 mm) sealed fasteners internally. Panels can be removed without affecting the structural integrity of the aluminum frame structure.
- 2" (51 mm) thick double wall construction to sustain high static pressure up to 10 in. w.g. (2,500 Pa).
- Structural steel fan bases are internally spring-isolated.
- AMCA-rated forward-curved (DWDI), housed airfoil (DWDI), or plenum fans (SWSI) are available.
- Full walk-on floor construction with 2" (51 mm) thick double wall foam panel structure.
- AHRI certified coils in 1/2" (12 mm) or 5/8" (16 mm) O.D. copper tubes. 1" (25 mm) O.D. steam distributing coils are also available upon request.

### Design Flexibility:

- Units are customized to your particular application.
- Wide ranges of unit sizes are available based on CFM (m<sup>3</sup>/hr.) requirement.

- Units can be designed for indoor or outdoor applications. Only indoor units are available in vertical configurations.
- Special third-party vendor items such as humidifiers, air blenders, evaporative coolers and integral face & bypass (IFB) coils can be factory mounted.
- Units can be designed with multiple fans for lower profiles or redundant.
- Full selection of air filters to meet indoor air quality standards operation.
- Outdoor units can be provided with roof curbs.

### Shipping

Flatbed trailers are used to ship air handling units that are less than or equal to 108" (2743 mm) tall and 102" (2591 mm) wide. Units less than or equal to 144" (3658 mm) wide and 312" (7925 mm) in direction of airflow can be built and shipped as one piece. Demounts should be added when using these dimensions. As long as there are no shipping limitations, multiple section air handlers ship as a single factory assembled unit. Modular sections may then be demounted in the field by others. Contact factory for units which exceed 133" (3378 mm) tall or 138" (3505 mm) wide.



# Unit Selection Guidelines

## Foam Panel Construction

### All Dimensions based on 2" (51 mm) thick casing walls

#### Getting Started

The following information must be known in order to properly design a Thermal custom air handling unit:

1. Total Unit Supply Airflow (CFM / m<sup>3</sup> / hr.)
2. Total Static Pressure (in. w.g. / Pa)
3. Unit Configuration
4. Coil Conditions
5. Filtration Requirements

If you are only provided with the external static pressure (ESP) use the quick pressure drop tables on the following pages to establish the total static pressure (TSP) of the unit.

#### Step 1:

Using a copy of the selection template provided at the back of the selection catalog, select whether the unit is indoor or outdoor. Next, enter the CFM (m<sup>3</sup>/hr.) and TSP of each fan.

#### Step 2:

Now that you have established the TSP and CFM (m<sup>3</sup>/hr.) use the fan selection software to pick the proper fan(s). Make sure to record the type of fan(s), required horsepower(s), and motor frame size(s).

#### Fan Type Guidelines

The fans that produce the highest mechanical efficiency are DWDI housed airfoil. However, when you have a blow through application, un-ducted discharge system effect losses often offset their efficiency. While DWDI housed airfoil fans can be used in applications greater than 4" w.g. (995 Pa), DWDI forward curved fans offer quiet operation for return air applications and static pressures less than 4" w.g. (995 Pa).

SWSI Plenum fans pressurize the entire plenum and generate very little velocity pressure, making them ideal for blow through applications and multiple supply air duct openings requirement. While most manufacturers use 8 or 9 bladed plenum fan wheels, Thermal Corporation uses 12 bladed fan wheels.

#### Step 3:

Record the minimum cabinet height and length required for your fan from the fan reference tables. Motor position and size determine the minimum cabinet width.

#### Step 4:

Now turn to the unit selection table. Locate the selection that meets your airflow requirements using your total airflow. Move right and down to any other block that will work if cabinet height and width is less than the minimum required for the fan. Enter the cabinet size in the space provided on the selection template.

#### Step 5:

From the unit selection grid, enter the coil finned height and width. Proceed to the component section and select the required modules.

**Note:** Alternate unit sizes are available. Use the following guidelines to help figure out available fin height and length for a given unit height and width:

#### Fin Height

1. Standard units with 1 coil high, allow fin height + 11" (279 mm)
2. Standard units with 2 coils high, allow fin height + 13" (330 mm)
3. Standard units with 3 coils high, allow fin height + 15" (381 mm)

#### Fin Length

1. Standard units with 1 coil wide, allow fin length + 14" (356 mm)
2. Outdoor units with a 12" (305 mm) internal pipe chase, allow total fin length + 30" (762 mm)

#### Miscellaneous Options

1. Cleanable return bends, allow fin length + 15" (381 mm)
2. 4" (102 mm) connections, allow fin height + 12" (305 mm) and fin length + 16" (406 mm)

**Note:** These guidelines do not include outdoor roof pitch and are based on 5" (127 mm) unit base, 2" (51 mm) casing and up to 3" (76 mm) coil connections.

**T<sup>2</sup> Series Unit Dimensions • Flat Filter and Coil Selection Table**

**IMPERIAL**

Cabinet	UW	30.750	36.750	42.750	48.750	54.750	60.750	66.750	72.750	78.750	84.750
UH	Coil	FL16	FL22	FL28	FL34	FL40	FL46	FL52	FL58	FL64	FL70
28.375	FH15	(1) 12x24	(1) 12x24	(1) 12x24	(1) 12x24	(2) 12x24	(2) 12x24	(2) 12x24	(2) 12x24		
		2.00 / 1000	2.00 / 1000	2.00 / 1000	2.00 / 1000	4.00 / 2000	4.00 / 2000	4.00 / 2000	4.00 / 2000		
33.375	FH21	(1) 20x24	(1) 20x24	(1) 20x24	(2) 20x20	(2) 20x24	(2) 20x24	(3) 20x20	(3) 20x20	(3) 20x24	(4) 20x20
		3.33 / 1665	3.33 / 1665	3.33 / 1665	5.56 / 2780	6.67 / 3335	6.67 / 3333	8.33 / 4165	8.33 / 4165	10.00 / 5000	11.11 / 5555
37.375	FH24	(1) 24x24	(1) 12x24	(2) 20x24	(2) 24x24	(1) 12x24	(1) 12x24	(2) 20x24	(3) 24x24	(4) 20x24	
		4.00 / 2000	5.33 / 2665	6.67 / 3335	8.00 / 4000	8.67 / 4335	10.00 / 5000	10.67 / 5335	12.00 / 6000	13.33 / 6665	
39.375	FH27	(1) 24x24	(1) 12x24	(2) 20x24	(2) 24x24	(1) 12x24	(1) 12x24	(2) 20x24	(3) 24x24	(4) 20x24	
		2.00 / 1000	6.00 / 3000	6.67 / 3335	8.00 / 4000	8.67 / 4335	10.00 / 5000	10.67 / 5335	12.00 / 6000	13.33 / 6665	
45.375	FH33	(1) 12x24	(1) 12x24	(1) 20x24	(2) 20x24	(2) 12x24	(2) 12x24	(2) 12x24	(2) 12x24	(3) 12x24	(3) 12x24
		5.33 / 2665	5.33 / 2665	10.67 / 5335	10.67 / 5335	10.67 / 5335	10.67 / 5335	10.67 / 5335	16.00 / 8000	16.00 / 8000	
50.375	FH39	(1) 12x24	(4) 20x20	(4) 20x24	(4) 20x24	(6) 20x20	(6) 20x20	(6) 20x24	(6) 20x24	(6) 20x24	(6) 20x24
		6.00 / 3000	11.11 / 5555	13.33 / 6665	13.33 / 6665	16.67 / 8335	16.67 / 8335	20.00 / 10000	20.00 / 10000	18.96 / 9480	
53.375	FH42	(1) 24x24	(4) 20x20	(4) 20x24	(4) 20x24	(6) 20x20	(2) 20x20	(6) 20x24	(8) 20x20		
		11.11 / 5555	13.33 / 6665	13.33 / 6665	16.67 / 8335	18.89 / 9445	20.00 / 10000	22.22 / 11110			
57.375	FH45	(4) 24x24	(4) 24x24	(6) 20x24	(4) 20x24	(2) 24x24	(4) 20x24	(6) 24x24	(8) 20x24		
		16.00 / 8000	16.00 / 8000	20.00 / 10000	21.33 / 10665	24.00 / 12000	26.66 / 13330				
60.375	FH48	(4) 24x24	(4) 24x24	(6) 20x24	(4) 20x24	(6) 24x24	(6) 24x24	(8) 20x24			
		16.00 / 8000	16.00 / 8000	20.00 / 10000	21.33 / 10665	24.00 / 12000	26.67 / 13335				
66.375	FH54	(4) 24x24	(6) 20x24	(4) 20x24	(6) 24x24	(8) 20x24					
		16.00 / 8000	20.00 / 10000	21.33 / 10665	24.00 / 12000	26.67 / 13335					
73.375	FH(2)30	(9) 20x20	(3) 20x20	(9) 20x24	(12) 20x20						
		25.00 / 12500	28.33 / 14165	30.00 / 15000	33.33 / 16665						
81.375	FH(2)33	(3) 20x24	(9) 24x24	(12) 20x24							
		34.00 / 17000	36.00 / 18000	40.00 / 20000							
87.375	FH(2)36	(9) 24x24	(12) 20x24								
		36.00 / 18000	40.00 / 20000								
93.375	FH(2)39	(16) 20x20									
		44.44 / 22220									
98.375	FH(2)42	(37.92 / 18960)									
		37.92 / 18960									
111.375	FH(2)48										

**LEGEND**  
UH = Cabinet Height (inches)  
UW = Cabinet Width (inches)  
FH = Coil Fin Height (inches)  
FL = Coil Fin Length (inches)  
Coil Face Area : (Qty) FH x FL  
Filter Face Area: (Qty) H x W  
Example:  
(1) 12 x 24 Filter (Qty) H x W  
Filter 6.67/3333 Face Area (Ft<sup>2</sup>)/Q (CFM)  
Coil 1.67/833 Face Area (Ft<sup>2</sup>)/Q (CFM)  
Calculations are based on 500 FPM velocity

Based on 5" unit base and 2.375" double wall and roof construction.

T<sup>2</sup> Series Unit Dimensions • Flat Filter and Coil Selection Table

**IMPERIAL**

Cabinet	UW	90.750	96.750	102.750	108.750	114.750	120.750	126.750	132.750	138.750
UH	Coil	FL76	FL82	FL88	FL94	FL100	FL106	FL112	FL118	FL124
28.375	FH15	<div style="border: 1px solid black; padding: 5px;"> <p align="center"><b>LEGEND</b></p> <p>UH = Cabinet Height (inches)            UW = Cabinet Width (inches)            FH = Coil Fin Height (inches)            FL = Coil Fin Length (inches)            Coil Face Area : (Qty) FH x FL            Filter Face Area: (Qty) H x W            Example:  <div style="display: inline-block; border: 1px solid black; padding: 2px; margin-right: 5px;"> <b>(1) 12 x 24</b>  <b>(3) 24 x 24</b>            14.00 / 7000         </div>           Filter Face Area (Ft<sup>2</sup>)/Q (CFM)            Coil <b>12.67/6333</b> Face Area (Ft<sup>2</sup>)/Q (CFM)  <i>Calculations are based on 500 FPM velocity</i> </p></div>								
33.375	FH21									
37.375	FH24	(1) 12x24 (3) 24x24 14.00 / 7000 12.67 / 6335	(2) 20x24 (2) 24x24 14.67 / 7335 13.67 / 6835							
39.375	FH27	(1) 12x24 (3) 24x24 14.00 / 7000 14.25 / 7125	(2) 20x24 (2) 24x24 14.67 / 7335 15.38 / 7690	(4) 24x24 16.00 / 8000 16.50 / 8250						
45.375	FH33	(3) 12x24 (3) 20x24 16.00 / 8000 17.42 / 8710	(3) 12x24 (3) 20x24 16.00 / 8000 18.79 / 9395	(4) 12x24 (4) 20x24 21.33 / 10665 20.17 / 10085	(4) 12x24 (4) 20x24 21.33 / 10665 21.54 / 10770	(4) 12x24 (4) 20x24 21.33 / 10665 22.92 / 11460	(4) 12x24 (4) 20x24 21.33 / 10665 24.29 / 12145			
50.375	FH39	(8) 20x20 22.22 / 11110 20.58 / 10290	(4) 20x20 (4) 20x24 24.44 / 12220 22.21 / 11105	(8) 20x24 26.67 / 13335 23.83 / 11915	(10) 20x20 27.78 / 13890 25.46 / 12730	(6) 20x20 (4) 20x24 30.00 / 15000 27.08 / 13540	(4) 20x20 (6) 20x24 31.11 / 15555 28.71 / 14355	(12) 20x20 33.33 / 16665 30.33 / 15165	(10) 20x20 (2) 20x24 34.44 / 17220 31.96 / 15980	
53.375	FH42	(8) 20x20 22.22 / 11110 22.17 / 11085	(4) 20x20 (4) 20x24 24.44 / 12220 23.92 / 11960	(8) 20x24 26.67 / 13335 25.67 / 12835	(10) 20x20 27.78 / 13890 27.42 / 13710	(6) 20x20 (4) 20x24 30.00 / 15000 29.17 / 14585	(4) 20x20 (6) 20x24 31.11 / 15555 30.92 / 15460	(12) 20x20 33.33 / 16665 32.67 / 16335	(8) 20x20 (4) 20x24 35.56 / 17780 34.42 / 17210	(6) 20x20 (6) 20x24 36.67 / 18335 36.17 / 18085
57.375	FH45	(6) 20x24 (2) 24x24 28.00 / 14000 23.75 / 11875	(4) 20x24 (4) 24x24 29.33 / 14665 25.63 / 12815	(8) 24x24 32.00 / 16000 27.50 / 13750	(8) 20x24 (2) 24x24 34.67 / 17335 29.38 / 14690	(6) 20x24 (4) 24x24 36.00 / 18000 31.25 / 15625	(2) 20x24 (8) 24x24 38.67 / 19335 33.13 / 16565	(10) 24x24 (8) 24x24 40.00 / 20000 35.00 / 17500	(10) 20x24 (2) 24x24 41.33 / 20665 36.88 / 18440	(6) 20x24 (6) 24x24 44.00 / 22000 38.75 / 19375
60.375	FH48	(6) 20x24 (2) 24x24 28.00 / 14000 25.33 / 12665	(4) 20x24 (4) 24x24 29.33 / 14665 27.33 / 13665	(8) 24x24 32.00 / 16000 29.33 / 14665	(4) 20x24 (2) 24x24 34.67 / 17335 31.33 / 15665	(6) 20x24 (4) 24x24 36.00 / 18000 33.33 / 16665	(2) 20x24 (8) 24x24 38.67 / 19335 35.33 / 17665	(10) 24x24 (8) 24x24 40.00 / 20000 37.33 / 18665	(10) 20x24 (2) 24x24 41.33 / 20665 39.33 / 19665	(6) 20x24 (6) 24x24 44.00 / 22000 41.33 / 20665
66.375	FH54	(6) 20x24 (2) 24x24 28.00 / 14000 28.50 / 14250	(2) 20x24 (6) 24x24 30.67 / 15335 30.75 / 15375	(8) 24x24 32.00 / 16000 33.00 / 16500	(8) 20x24 (2) 24x24 34.67 / 17335 35.25 / 17625	(6) 20x24 (4) 24x24 36.00 / 18000 37.50 / 18750	(2) 20x24 (8) 24x24 38.67 / 19335 39.75 / 19875	(10) 24x24 (8) 24x24 40.00 / 20000 42.00 / 21000	(10) 20x24 (2) 24x24 41.33 / 20665 44.25 / 22125	(6) 20x24 (6) 24x24 44.00 / 22000 46.50 / 23250
73.375	FH(2)30	(9) 20x20 (3) 20x24 35.00 / 17500 31.67 / 15835	(3) 20x20 (9) 20x24 38.33 / 19165 34.17 / 17085	(12) 20x24 40.00 / 20000 36.67 / 18335	(12) 20x20 (3) 20x24 43.33 / 21665 39.17 / 19585	(9) 20x20 (6) 20x24 45.00 / 22500 41.67 / 20835	(3) 20x20 (12) 20x24 48.30 / 24150 44.17 / 22085	(15) 20x24 50.00 / 25000 46.67 / 23335	(12) 20x20 (6) 20x24 53.33 / 26665 49.17 / 24585	(9) 20x20 (9) 20x24 55.00 / 27500 51.67 / 25835
81.375	FH(2)33	(9) 20x24 (3) 24x24 42.00 / 21000 34.83 / 17415	(3) 20x24 (9) 24x24 46.00 / 23000 37.58 / 18790	(12) 24x24 48.00 / 24000 40.33 / 20165	(12) 20x24 (3) 24x24 52.00 / 26000 43.08 / 21540	(9) 20x24 (6) 24x24 54.00 / 27000 45.83 / 22915	(3) 20x24 (12) 24x24 58.00 / 29000 48.58 / 24290	(15) 24x24 60.00 / 30000 51.33 / 25665	(12) 20x24 (6) 24x24 64.00 / 32000 54.08 / 27040	(9) 20x24 (9) 24x24 66.00 / 33000 56.83 / 28415
87.375	FH(2)36	(12) 20x24 40.00 / 20000 38.00 / 19000	(9) 20x24 (3) 24x24 42.00 / 21000 41.00 / 20500	(6) 20x24 (6) 24x24 44.00 / 22000 44.00 / 22000	(3) 20x24 (9) 24x24 46.00 / 23000 47.00 / 23500	(9) 20x24 (6) 24x24 54.00 / 27000 50.00 / 25000	(6) 20x24 (9) 24x24 56.00 / 28000 53.00 / 26500	(15) 24x24 60.00 / 30000 56.00 / 28000	(12) 20x24 (6) 24x24 64.00 / 32000 59.00 / 29500	
93.375	FH(2)39	(12) 20x20 (4) 20x24 46.67 / 23335 41.17 / 20585	(4) 20x20 (12) 20x24 51.11 / 25555 44.42 / 22210	(16) 20x24 53.33 / 26665 47.67 / 23835	(16) 20x20 (4) 20x24 57.78 / 28890 50.92 / 25460	(12) 20x20 (8) 20x24 60.00 / 30000 54.17 / 27085	(4) 20x20 (16) 20x24 64.44 / 32220 57.42 / 28710	(20) 20x24 66.67 / 33335 60.67 / 30335		
98.375	FH(2)42	(12) 20x20 (4) 20x24 46.67 / 23335 44.33 / 22165	(4) 20x20 (12) 20x24 51.11 / 25555 47.83 / 23915	(16) 20x24 53.33 / 26665 51.33 / 25665	(16) 20x20 (4) 20x24 57.78 / 28890 54.83 / 27415	(12) 20x20 (8) 20x24 60.00 / 30000 58.33 / 29165	(4) 20x20 (16) 20x24 64.44 / 32220 61.83 / 30915			
111.375	FH(2)48		(4) 20x24 (12) 24x24 61.33 / 30665 54.67 / 27335	(16) 24x24 64.00 / 32000 58.67 / 29335	(16) 20x24 (4) 24x24 69.33 / 34665 62.67 / 31335					

Based on 5" unit base and 2.375" double wall and roof construction.

T<sup>2</sup> Series Unit Dimensions • Flat Filter and Coil Selection Table

										<b>METRIC</b>	
Cabinet	UW	781	933	1086	1238	1391	1543	1695	1848	2000	2153
UH	Coil	FL406	FL559	FL711	FL864	FL1016	FL1168	FL1321	FL1473	FL1626	FL1778
721	FH381	(1) 305x610	(1) 305x610	(1) 305x610	(1) 305x610	(2) 305x610	(2) 305x610	(2) 305x610	(2) 305x610		
		0.19 / 1737	0.19 / 1737	0.19 / 1737	0.19 / 1737	0.37 / 3383	0.37 / 3383	0.37 / 3383	0.37 / 3383		
848	FH533	(1) 508x610	(1) 508x610	(1) 508x610	(2) 508x508	(2) 508x610	(2) 508x610	(3) 508x508	(3) 508x508	(3) 508x610	(4) 508x508
		0.31 / 2835	0.31 / 2835	0.31 / 2835	0.52 / 4755	0.62 / 5669	0.62 / 5669	0.77 / 7041	0.77 / 7041	0.93 / 8504	1.03 / 9418
949	FH610	(1) 610x610	(1) 305x610 (1) 508x610	(2) 508x610	(2) 610x610	(1) 305x610 (2) 508x610	(1) 305x610 (2) 610x610	(2) 508x610 (1) 610x610	(3) 610x610	(4) 508x610	
		0.37 / 3383	0.46 / 4206	0.62 / 5669	0.74 / 6767	0.81 / 7407	0.93 / 8504	0.99 / 9053	1.12 / 10241	1.24 / 11339	
1000	FH686	(1) 610x610	(1) 305x610 (1) 610x610	(2) 508x610	(2) 610x610	(1) 305x610 (2) 508x610	(1) 305x610 (2) 610x610	(2) 508x610 (1) 610x610	(3) 610x610	(4) 508x610	
		0.37 / 3383	0.56 / 5121	0.62 / 5669	0.74 / 6767	0.81 / 7407	0.93 / 8504	0.99 / 9053	1.12 / 10241	1.24 / 11339	
1153	FH838	(1) 610x610	(1) 305x610 (1) 508x610	(2) 508x610	(2) 610x610	(1) 305x610 (2) 508x610	(1) 305x610 (2) 610x610	(2) 508x610 (1) 610x610	(3) 610x610	(4) 508x610	
		0.37 / 3383	0.56 / 5121	0.62 / 5669	0.74 / 6767	0.81 / 7407	0.93 / 8504	0.99 / 9053	1.12 / 10241	1.24 / 11339	
1280	FH991	(1) 305x610 (1) 610x610	(1) 305x610 (1) 508x610	(2) 508x610	(2) 610x610	(2) 305x610 (2) 508x610	(2) 305x610 (2) 508x610	(2) 305x610 (2) 508x610	(3) 305x610 (3) 508x610	(3) 305x610 (3) 508x610	
		0.56 / 5121	0.50 / 4572	0.99 / 9053	0.99 / 9053	0.99 / 9053	0.99 / 9053	0.99 / 9053	0.99 / 9053	1.49 / 13625	1.49 / 13625
1356	FH1067	(1) 305x610 (1) 610x610	(4) 508x508	(4) 508x610	(4) 508x610	(4) 508x610	(6) 508x508	(6) 508x508	(6) 508x610	(6) 508x610	
		0.56 / 5121	1.03 / 9418	1.24 / 11339	1.24 / 11339	1.55 / 14173	1.55 / 14173	1.86 / 17008	1.86 / 17008	2.07 / 18928	
1457	FH1143	(1) 610x610	(4) 508x508	(4) 508x610	(4) 508x610	(6) 508x508	(6) 508x508	(6) 508x610	(6) 508x610	(8) 508x508	
		0.70 / 6401	0.86 / 7864	1.01 / 9235	1.16 / 10607	1.31 / 11979	1.46 / 13350	1.61 / 14722	1.76 / 16093	1.92 / 8412	1.09 / 9967
1534	FH1219	(1) 610x610	(4) 508x508	(4) 508x610	(4) 508x610	(6) 508x508	(6) 508x508	(6) 508x610	(6) 508x610	(8) 508x610	
		1.16 / 10607	1.34 / 12253	1.51 / 13807	1.69 / 15453	1.86 / 17008	1.98 / 18105	2.32 / 21214	2.48 / 22677	1.24 / 11339	1.43 / 13076
1686	FH1372	(1) 610x610	(4) 508x508	(4) 508x610	(4) 508x610	(6) 508x508	(6) 508x508	(6) 508x610	(6) 508x610	(8) 508x610	
		1.61 / 14722	1.86 / 17008	1.98 / 18105	2.32 / 21214	2.48 / 22677	2.63 / 24049	2.79 / 25512	3.10 / 28346	1.63 / 14905	1.81 / 16551
1864	FH(2)762	(9) 508x508	(3) 508x508 (6) 508x610	(9) 508x610	(12) 508x508						
		2.33 / 21306	2.63 / 24049	2.79 / 25512	3.10 / 28346						
2067	FH(2)838	(3) 508x508 (6) 610x610	(9) 610x610	(12) 508x610							
		3.16 / 28895	3.35 / 30632	3.72 / 34016							
2219	FH(2)914	(9) 610x610	(12) 508x610								
		2.73 / 24963	2.98 / 27249								
2372	FH(2)991	(9) 610x610	(12) 508x610								
		3.35 / 30632	3.72 / 34016								
2499	FH(2)1067	(16) 508x508									
		4.13 / 37765	3.53 / 32278								
2829	FH(2)1219	(1) 305x610									
		0.19 / 472									

**LEGEND**  
UH = Cabinet Height (inches)  
UW = Cabinet Width (inches)  
FH = Coil Fin Height (inches)  
FL = Coil Fin Length (inches)  
Coil Face Area : (Qty) FH x FL  
Filter Face Area: (Qty) H x W  
Example:  
**(1) 305x610** Filter (Qty) H x W  
Filter **0.19/472** Face Area (Ft<sup>2</sup>)/Q (CFM)  
Coil **0.16/393** Face Area (Ft<sup>2</sup>)/Q (CFM)  
Calculations are based on 500 FPM velocity

Based on 127 mm unit base and 60 mm double wall and roof construction.



T<sup>2</sup> Series Unit Dimensions • Flat Filter and Coil Selection Table

**METRIC**

Cabinet	UW	2305	2457	2610	2762	2915	3067	3219	3372	3524												
UH	Coil	FL1930	FL2083	FL2235	FL2388	FL2540	FL2692	FL2845	FL2997	FL3150												
721	FH381	<div style="border: 1px solid black; padding: 5px;"> <p><b>LEGEND</b></p> <p>UH = Cabinet Height (inches)            UW = Cabinet Width (inches)            FH = Coil Fin Height (inches)            FL = Coil Fin Length (inches)            Coil Face Area : (Qty) FH x FL            Filter Face Area: (Qty) H x W  <b>Example:</b></p> <table border="1" style="margin-left: auto; margin-right: auto;"> <tr> <td>Filter</td> <td>(1) 305 x 610</td> <td>Face Area (Ft<sup>2</sup>)/Q (CFM)</td> </tr> <tr> <td></td> <td>(3) 610 x 610</td> <td></td> </tr> <tr> <td>Coil</td> <td>1.30 / 3304</td> <td>Face Area (Ft<sup>2</sup>)/Q (CFM)</td> </tr> <tr> <td></td> <td>1.18 / 2989</td> <td></td> </tr> </table> <p><i>Calculations are based on 500 FPM velocity</i></p> </div>									Filter	(1) 305 x 610	Face Area (Ft <sup>2</sup> )/Q (CFM)		(3) 610 x 610		Coil	1.30 / 3304	Face Area (Ft <sup>2</sup> )/Q (CFM)		1.18 / 2989	
Filter	(1) 305 x 610										Face Area (Ft <sup>2</sup> )/Q (CFM)											
	(3) 610 x 610																					
Coil	1.30 / 3304	Face Area (Ft <sup>2</sup> )/Q (CFM)																				
	1.18 / 2989																					
848	FH533																					
949	FH610	(1) 305x610 1.30 / 11887 1.18 / 10790	(2) 508x610 (2) 610x610 1.36 / 12436 1.27 / 11613																			
1000	FH686	(1) 305x610 (3) 610x610 1.30 / 11887	(2) 508x610 (2) 610x610 1.36 / 12436	(4) 610x610 1.49 / 13625																		
1153	FH838	(3) 305x610 (3) 508x610 1.49 / 13625	(3) 305x610 (3) 508x610 1.49 / 13625	(4) 305x610 (4) 508x610 1.98 / 18105	(4) 305x610 (4) 508x610 1.98 / 18105	(4) 305x610 (4) 508x610 1.98 / 18105	(4) 305x610 (4) 508x610 1.98 / 18105															
1280	FH991	(8) 508x508 2.06 / 18837 1.91 / 17465	(4) 508x508 (4) 508x610 2.27 / 20757 2.07 / 18928	(8) 508x610 2.48 / 22677	(10) 508x508 2.58 / 23592 2.22 / 20300	(6) 508x508 (4) 508x610 2.79 / 25512 2.52 / 23043	(4) 508x508 (6) 508x610 2.89 / 26426 2.67 / 24414	(12) 508x508 3.10 / 28346 2.82 / 25786	(10) 508x508 (2) 508x610 3.20 / 29261													
1356	FH1067	(8) 508x508 2.07 / 18928 2.06 / 18837	(4) 508x508 (4) 508x610 2.27 / 20757 2.22 / 20300	(8) 508x610 2.48 / 22769	(10) 508x508 2.58 / 23592 2.39 / 21854	(6) 508x508 (4) 508x610 2.79 / 25512 2.55 / 23317	(4) 508x508 (6) 508x610 2.89 / 26426 2.71 / 24780	(12) 508x508 3.10 / 28346 2.88 / 26335	(8) 508x508 (4) 508x610 3.20 / 29261	(6) 508x508 (6) 508x610 3.41 / 31181 3.26 / 29809												
1457	FH1143	(6) 508x610 (2) 610x610 2.60 / 23774	(4) 508x610 (4) 610x610 2.73 / 24963	(8) 610x610 2.98 / 27249	(8) 508x610 (2) 610x610 3.22 / 29444	(6) 508x610 (4) 610x610 3.35 / 30632	(2) 508x610 (8) 610x610 3.60 / 32918	(10) 610x610 3.72 / 34016	(10) 508x610 (2) 610x610 3.84 / 35113	(6) 508x610 (6) 610x610 4.10 / 37490												
1534	FH1219	(6) 508x610 (2) 610x610 2.60 / 23774	(4) 508x610 (4) 610x610 2.73 / 24963	(8) 610x610 2.98 / 27249	(8) 508x610 (2) 610x610 3.22 / 29444	(6) 508x610 (4) 610x610 3.35 / 30632	(2) 508x610 (8) 610x610 3.60 / 32918	(10) 610x610 3.72 / 34016	(10) 508x610 (2) 610x610 3.84 / 35113	(6) 508x610 (6) 610x610 4.10 / 37490												
1686	FH1372	(6) 508x610 (2) 610x610 2.60 / 23774	(4) 508x610 (6) 610x610 2.85 / 26060	(8) 610x610 2.98 / 27249	(8) 508x610 (2) 610x610 3.22 / 29444	(6) 508x610 (4) 610x610 3.35 / 30632	(2) 508x610 (6) 610x610 3.47 / 31730	(10) 610x610 3.72 / 34016	(10) 508x610 (2) 610x610 3.84 / 35113	(6) 508x610 (6) 610x610 4.10 / 37490												
1864	FH(2)762	(9) 508x508 (3) 508x610 3.26 / 29809	(3) 508x508 (9) 508x610 3.56 / 32553	(12) 508x610 3.72 / 34016	(12) 508x508 (3) 508x610 4.03 / 36850	(9) 508x508 (6) 508x610 4.19 / 38313	(3) 508x508 (12) 508x610 4.49 / 41057	(15) 508x610 4.65 / 42520	(12) 508x508 (6) 508x610 4.96 / 45354	(9) 508x508 (9) 508x610 5.12 / 46817												
2067	FH(2)838	(9) 508x610 (3) 610x610 3.91 / 35753	(3) 508x610 (9) 610x610 4.28 / 39136	(12) 610x610 4.46 / 40782	(12) 508x610 (3) 610x610 4.84 / 44257	(9) 508x610 (6) 610x610 5.02 / 45903	(3) 508x610 (12) 610x610 5.39 / 49286	(15) 610x610 5.58 / 51024	(12) 508x610 (6) 610x610 5.95 / 54407	(9) 508x610 (9) 610x610 6.14 / 56144												
2219	FH(2)914	(12) 508x610 3.72 / 34016	(9) 508x610 (3) 610x610 3.91 / 35753	(6) 508x610 (6) 610x610 4.09 / 37399	(3) 508x610 (9) 610x610 4.28 / 39136	(9) 508x610 (6) 610x610 5.02 / 45902	(6) 508x610 (9) 610x610 5.21 / 47640	(15) 610x610 5.58 / 51024	(12) 508x610 (6) 610x610 5.95 / 54407	(9) 508x610 (9) 610x610 6.14 / 56144												
2372	FH(2)991	(12) 508x508 (4) 508x610 4.34 / 39685	(4) 508x508 (12) 508x610 4.75 / 43434	(16) 508x610 4.96 / 45354	(16) 508x508 (4) 508x610 5.37 / 49103	(12) 508x508 (8) 508x610 5.58 / 51024	(4) 508x508 (16) 508x610 5.99 / 54773	(20) 508x610 6.20 / 56693														
2499	FH(2)1067	(12) 508x508 (4) 508x610 4.34 / 39685	(4) 508x508 (12) 508x610 4.75 / 43434	(16) 508x610 4.96 / 45354	(16) 508x508 (4) 508x610 5.37 / 49103	(12) 508x508 (8) 508x610 5.58 / 51024	(4) 508x508 (16) 508x610 5.99 / 54773															
2829	FH(2)1219		(4) 508x610 (12) 610x610 5.70 / 52121	(16) 610x610 5.95 / 54407	(16) 508x610 (4) 610x610 6.45 / 58979																	
			5.08 / 46452	5.47 / 50018	5.83 / 53310																	

Based on 127 mm unit base and 60 mm double wall and roof construction.

**Notes:**

## T Series: Tubular Frame



## Unit Selection Guidelines

### Tubular Frame Construction

Thermal Corporation's **T Series** (Tubular Frame) of air handlers are constructed around a welded tubular frame. The flexibility of the tubular design lends itself to a rigid structural design with wide range of sizes and configurations. Tubular welded frame provides a customizable platform with an optimum balance in quality and value.

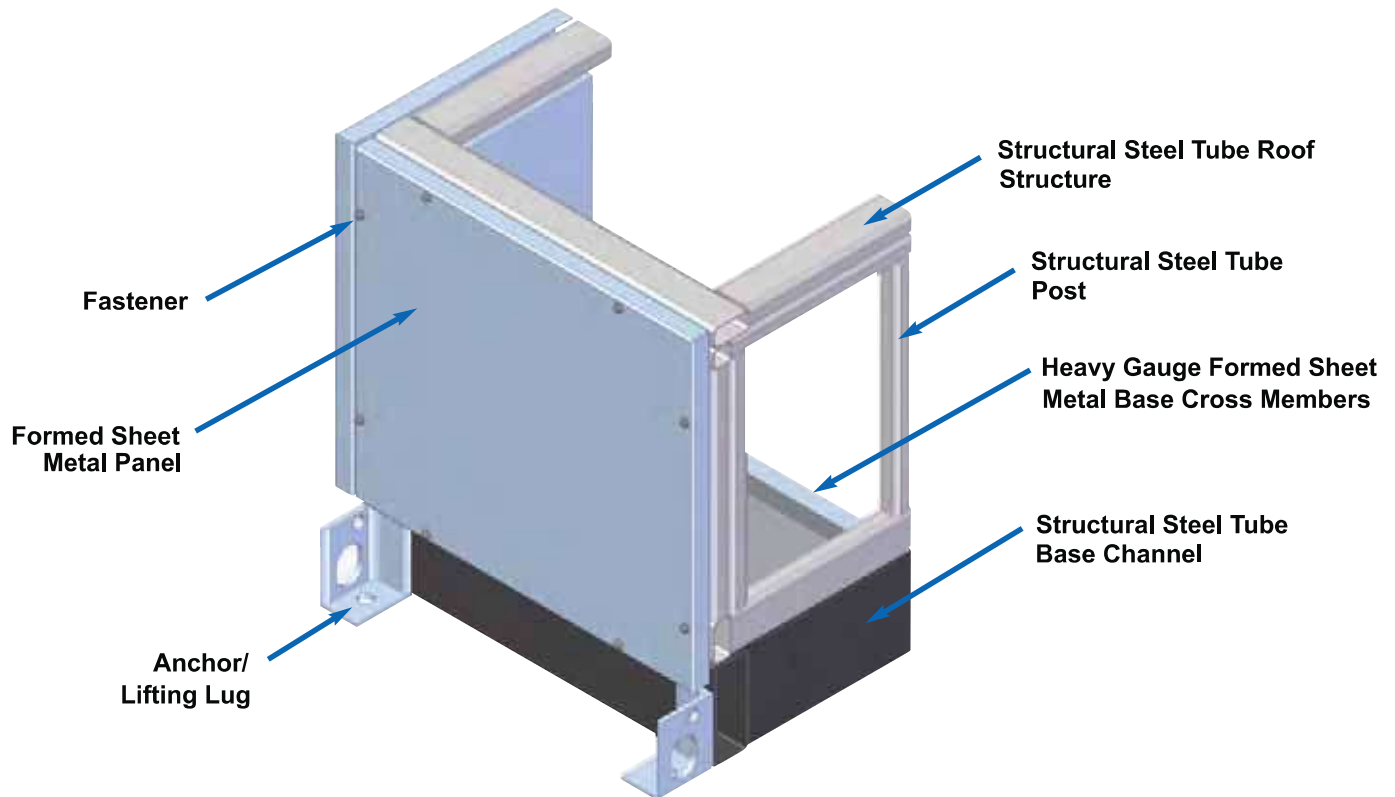

### Construction Features:

- 16 gauge (1.5 mm) galvanized steel panels with closed cell neoprene gasket around the perimeter. All panels are installed with 1/4" (6 mm) sealed fasteners. Panels can be removed without affecting the structural integrity of the welded tubular steel frame.
- 2" (51 mm), 3" (76 mm), or 4" (102 mm) thick walls with single or double wall construction.
- Structural steel fan bases are internally spring-isolated.
- AMCA-rated forward-curved (DWDI), housed airfoil (DWDI), or plenum fans (SWSI) are available.
- Full walk-on floor of galvanized steel. True "double bottom" construction with 4" (102 mm) thick insulation.
- AHRI certified coils in 1/2" (12mm) or 5/8" (16 mm) O.D. copper tubes. 1" (25 mm) O.D. steam distributing coils are also available upon request.

### Design Flexibility:

- Units are customized to your particular application.
- Wide ranges of unit sizes are available based on CFM (m<sup>3</sup>/hr.) requirement.

- Units can be designed for indoor or outdoor applications. Only indoor units are available in vertical configurations.
- Special third-party vendor items such as humidifiers, air blenders, evaporative coolers and integral face & bypass (IFB) coils can be factory mounted.
- Units can be designed with multiple fans for lower profiles or redundant operation.
- Full selection of air filters to meet indoor air quality standards.
- Outdoor units can be provided with roof curbs.

### Shipping

Flatbed trailers are used to ship air handling units that are less than or equal to 108" (2743 mm) tall and 102" (2591 mm) wide. Units less than or equal to 144" (3658 mm) wide and 312" (7925 mm) in direction of airflow can be built and shipped as one piece. Demounts should be added when using these dimensions. As long as there are no shipping limitations, multiple section air handlers ship as a single factory assembled unit. Modular sections may then be demounted in the field by others. Contact factory for units which exceed 133" (3378 mm) tall or 138" (3505 mm) wide.



# Unit Selection Guidelines

## Tubular Frame Construction

### All Dimensions based on 2" (51 mm) thick casing walls

- For 3" (76 mm) thick casing walls, add 2" (51 mm) to the unit length, width and height.
- For 4" (102 mm) thick casing walls, add 4" (102 mm) to the unit length, width and height.

### Getting Started

The following information must be known in order to properly design a Thermal custom air handling unit:

1. Total Unit Supply Airflow (CFM / m<sup>3</sup>/hr.)
2. Total Static Pressure (in. w.g. / Pa)
3. Unit Configuration
4. Coil Conditions
5. Filtration Requirements

If you are only provided with the external static pressure (ESP) use the quick pressure drop tables on the following pages to establish the total static pressure (TSP) of the unit.

#### Step 1:

Using a copy of the selection template provided at the back of the selection catalog, select whether the unit is indoor or outdoor. Next, enter the CFM (m<sup>3</sup>/hr.) and TSP of each fan.

#### Step 2:

Now that you have established the TSP and CFM (m<sup>3</sup>/hr.) use the fan selection software to pick the proper fan(s). Make sure to record the type of fan(s), required horsepower(s), and motor frame size(s).

#### Fan Type Guidelines

The fans that produce the highest mechanical efficiency are DWDI housed airfoil. However, when you have a blow through application, un-ducted discharge system effect losses often offset their efficiency. While DWDI housed airfoil fans can be used in applications greater than 4" w.g. (995 Pa), DWDI forward curved fans offer quiet operation for return air applications and static pressures less than 4" w.g. (995 Pa).

SWSI Plenum fans pressurize the entire plenum and generate very little velocity pressure, making them ideal for blow through applications and multiple supply air duct openings requirement. While most manufacturers use 8 or 9 bladed plenum fan wheels, Thermal Corporation uses 12 bladed fan wheels.

#### Step 3:

Record the minimum cabinet height and length required for your fan from the fan reference tables. Motor position and size determine the minimum cabinet width.

#### Step 4:

Now turn to the unit selection table. Locate the selection that meets your airflow requirements using your total airflow. Move right and down to any other block that will work if cabinet height and width is less than the minimum required for the fan. Enter the cabinet size in the space provided on the selection template.

#### Step 5:

From the unit selection grid, enter the coil finned height and width. Proceed to the component section and select the required modules.

**Note:** Alternate unit sizes are available. Use the following guidelines to help figure out available fin height and length for a given unit height and width:

#### Fin Height

1. Standard units with 1 coil high, allow fin height + 11" (279 mm)
2. Standard units with 2 coils high, allow fin height + 13" (330 mm)
3. Standard units with 3 coils high, allow fin height + 15" (381 mm)

#### Fin Length

1. Standard units with 1 coil wide, allow fin length + 14" (356 mm)
2. Outdoor units with a 12" (305 mm) internal pipe chase, allow total fin length + 30" (762 mm)

#### Miscellaneous Options

1. Cleanable return bends, allow fin length + 15" (381 mm)
2. 4" (102 mm) connections, allow fin height + 12" (305 mm) and fin length + 16" (406 mm)

**Note:** These guidelines do not include outdoor roof pitch and are based on 5" (127 mm) unit base, 2" (51 mm) casing and up to 3" (76 mm) coil connections.

**T Series Unit Dimensions • Flat Filter and Coil Selection Table**

**IMPERIAL**

Cabinet	UW	30	36	42	48	54	60	66	72	78	84
UH	Coil	FL16	FL22	FL28	FL34	FL40	FL46	FL52	FL58	FL64	FL70
28	FH15	(1) 12x24	(1) 12x24	(1) 12x24	(1) 12x24	(2) 12x24	(2) 12x24	(2) 12x24	(2) 12x24		
		2.00 / 1000	2.00 / 1000	2.00 / 1000	2.00 / 1000	4.00 / 2000	4.00 / 2000	4.00 / 2000	4.00 / 2000		
33	FH21	(1) 20x24	(1) 20x24	(1) 20x24	(2) 20x20	(2) 20x24	(2) 20x24	(3) 20x20	(3) 20x20	(3) 20x24	(4) 20x20
		3.33 / 1665	3.33 / 1665	3.33 / 1665	5.56 / 2780	6.67 / 3335	6.67 / 3333	8.33 / 4165	8.33 / 4165	10.00 / 5000	11.11 / 5555
37	FH24	(1) 24x24	(1) 12x24	(1) 20x24	(2) 20x24	(2) 24x24	(1) 12x24	(1) 12x24	(2) 20x24	(3) 24x24	(4) 20x24
		4.00 / 2000	5.33 / 2665	6.67 / 3335	8.00 / 4000	8.00 / 4000	8.67 / 4335	10.00 / 5000	10.67 / 5335	12.00 / 6000	13.33 / 6665
39	FH27	(1) 24x24	(1) 12x24	(2) 20x24	(2) 24x24	(1) 12x24	(1) 12x24	(2) 20x24	(2) 24x24	(3) 24x24	(4) 20x24
		2.00 / 1000	6.00 / 3000	6.67 / 3335	8.00 / 4000	8.67 / 4335	10.00 / 5000	10.67 / 5335	10.67 / 5335	12.00 / 6000	13.33 / 6665
45	FH33	(1) 24x24	(1) 12x24	(2) 20x24	(2) 24x24	(1) 12x24	(1) 12x24	(2) 20x24	(2) 24x24	(3) 24x24	(4) 20x24
		4.13 / 2065	5.25 / 2625	6.38 / 3190	7.50 / 3750	8.63 / 4315	9.75 / 4875	10.88 / 5440	12.00 / 6000	13.13 / 6565	
50	FH39	(1) 12x24	(1) 12x24	(1) 20x24	(2) 20x24	(2) 20x24	(2) 20x24	(2) 20x24	(2) 20x24	(3) 12x24	(3) 12x24
		6.00 / 3000	11.11 / 5555	13.33 / 6665	13.33 / 6665	16.67 / 8335	16.67 / 8335	20.00 / 10000	20.00 / 10000	26.66 / 13330	26.66 / 13330
53	FH42	(1) 24x24	(4) 20x20	(4) 20x24	(4) 20x24	(6) 20x20	(6) 20x20	(6) 20x24	(6) 20x24	(6) 20x24	(8) 20x20
		7.58 / 3790	9.21 / 4605	10.83 / 5415	12.46 / 6230	14.08 / 7040	15.71 / 7855	17.33 / 8665	18.96 / 9480	20.59 / 10290	22.22 / 11110
57	FH45	(4) 20x20	(4) 20x24	(4) 20x24	(6) 20x20	(6) 20x20	(6) 20x24	(6) 20x24	(6) 24x24	(8) 20x24	(8) 20x24
		11.11 / 5555	13.33 / 6665	13.33 / 6665	16.67 / 8335	16.67 / 8335	20.00 / 10000	21.33 / 10665	24.00 / 12000	26.66 / 13330	26.66 / 13330
60	FH48	(4) 24x24	(4) 24x24	(6) 20x24	(4) 20x24	(6) 20x24	(6) 20x24	(6) 24x24	(6) 24x24	(8) 20x24	(8) 20x24
		12.50 / 6250	14.38 / 7190	16.25 / 8125	18.13 / 9065	20.00 / 10000	21.33 / 10665	24.00 / 12000	26.67 / 13335	26.67 / 13335	26.67 / 13335
66	FH54	(4) 24x24	(6) 20x24	(4) 20x24	(6) 20x24	(4) 20x24	(6) 24x24	(6) 24x24	(8) 20x24	(8) 20x24	(8) 20x24
		16.00 / 8000	20.00 / 10000	21.33 / 10665	24.00 / 12000	26.67 / 13335	28.33 / 14165	30.00 / 15000	33.33 / 16665	33.33 / 16665	33.33 / 16665
73	FH(2)30	(9) 20x20	(3) 20x20	(9) 20x24	(12) 20x20	(9) 20x20	(9) 20x24	(12) 20x20	(12) 20x20	(12) 20x20	(12) 20x20
		25.00 / 12500	28.33 / 14165	30.00 / 15000	33.33 / 16665	33.33 / 16665	36.67 / 18335	40.00 / 20000	44.44 / 22220	44.44 / 22220	44.44 / 22220
81	FH(2)33	(9) 20x20	(9) 24x24	(12) 20x24	(12) 20x24	(12) 20x24	(12) 20x24	(12) 20x24	(12) 20x24	(12) 20x24	(12) 20x24
		21.67 / 10835	24.17 / 12085	26.67 / 13335	29.17 / 14585	31.67 / 15835	34.17 / 17085	36.67 / 18335	39.17 / 19585	41.67 / 20835	44.17 / 22085
87	FH(2)36	(9) 24x24	(12) 20x24	(12) 20x24	(12) 20x24	(12) 20x24	(12) 20x24	(12) 20x24	(12) 20x24	(12) 20x24	(12) 20x24
		36.00 / 18000	40.00 / 20000	40.00 / 20000	40.00 / 20000	40.00 / 20000	40.00 / 20000	40.00 / 20000	40.00 / 20000	40.00 / 20000	40.00 / 20000
93	FH(2)39	(16) 20x20	(16) 20x20	(16) 20x20	(16) 20x20	(16) 20x20	(16) 20x20	(16) 20x20	(16) 20x20	(16) 20x20	(16) 20x20
		44.44 / 22220	44.44 / 22220	44.44 / 22220	44.44 / 22220	44.44 / 22220	44.44 / 22220	44.44 / 22220	44.44 / 22220	44.44 / 22220	44.44 / 22220
98	FH(2)42	(1) 12 x 24	Filter (Qty) H x W	6.67 / 3333	Face Area (Ft <sup>2</sup> )/Q (CFM)	1.67 / 833	Face Area (Ft <sup>2</sup> )/Q (CFM)				
		Filter	Coil								
111	FH(2)48										

**LEGEND**  
UH = Cabinet Height (inches)  
UW = Cabinet Width (inches)  
FH = Coil Fin Height (inches)  
FL = Coil Fin Length (inches)  
Coil Face Area : (Qty) FH x FL  
Filter Face Area: (Qty) H x W  
Example:  
(1) 12 x 24 Filter (Qty) H x W  
Filter 6.67/3333 Face Area (Ft<sup>2</sup>)/Q (CFM)  
Coil 1.67/833 Face Area (Ft<sup>2</sup>)/Q (CFM)  
Calculations are based on 500 FPM velocity

Based on 5" unit base and 2" double wall and roof construction.

T Series Unit Dimensions • Flat Filter and Coil Selection Table

**IMPERIAL**

Cabinet	UW	90	96	102	108	114	120	126	132	138
UH	Coil	FL76	FL82	FL88	FL94	FL100	FL106	FL112	FL118	FL124
28	FH15	<p><b>LEGEND</b>            UH = Cabinet Height (inches)            UW = Cabinet Width (inches)            FH = Coil Fin Height (inches)            FL = Coil Fin Length (inches)            Coil Face Area : (Qty) FH x FL            Filter Face Area: (Qty) H x W            Example:            (1) 12 x 24 Filter (Qty) H x W            (3) 24 x 24 Face Area (Ft<sup>2</sup>)/Q (CFM)            14.00 / 7000            12.67/6333 Coil Face Area (Ft<sup>2</sup>)/Q (CFM)            Calculations are based on 500 FPM velocity</p>								
33	FH21									
37	FH24	(1) 12x24 (3) 24x24 14.00 / 7000 12.67 / 6335	(2) 20x24 (2) 24x24 14.67 / 7335							
39	FH27	(1) 12x24 (3) 24x24 14.00 / 7000 14.25 / 7125	(2) 20x24 (2) 24x24 14.67 / 7335 15.38 / 7690	(4) 24x24 16.00 / 8000 16.50 / 8250						
45	FH33	(3) 12x24 (3) 20x24 16.00 / 8000 17.42 / 8710	(3) 12x24 (3) 20x24 16.00 / 8000 18.79 / 9395	(4) 12x24 (4) 20x24 21.33 / 10665 20.17 / 10085	(4) 12x24 (4) 20x24 21.33 / 10665 21.54 / 10770	(4) 12x24 (4) 20x24 21.33 / 10665 22.92 / 11460	(4) 12x24 (4) 20x24 21.33 / 10665 24.29 / 12145			
50	FH39	(8) 20x20 22.22 / 11110 20.58 / 10290	(4) 20x20 (4) 20x24 24.44 / 12220 22.21 / 11105	(8) 20x24 26.67 / 13335 23.83 / 11915	(10) 20x20 27.78 / 13890 25.46 / 12730	(6) 20x20 (4) 20x24 30.00 / 15000 27.08 / 13540	(4) 20x20 (6) 20x24 31.11 / 15555 28.71 / 14355	(12) 20x20 33.33 / 16665 30.33 / 15165	(10) 20x20 (2) 20x24 34.44 / 17220 31.96 / 15980	
53	FH42	(8) 20x20 22.22 / 11110 22.17 / 11085	(4) 20x20 (4) 20x24 24.44 / 12220 23.92 / 11960	(8) 20x24 26.67 / 13335 25.67 / 12835	(10) 20x20 27.78 / 13890 27.42 / 13710	(6) 20x20 (4) 20x24 30.00 / 15000 29.17 / 14585	(4) 20x20 (6) 20x24 31.11 / 15555 30.92 / 15460	(12) 20x20 33.33 / 16665 32.67 / 16335	(8) 20x20 (4) 20x24 35.56 / 17780 34.42 / 17210	(6) 20x20 (6) 20x24 36.67 / 18335 36.17 / 18085
57	FH45	(6) 20x24 (2) 24x24 28.00 / 14000 23.75 / 11875	(4) 20x24 (4) 24x24 29.33 / 14665 25.63 / 12815	(8) 24x24 32.00 / 16000 27.50 / 13750	(8) 20x24 (2) 24x24 34.67 / 17335 29.38 / 14690	(6) 20x24 (4) 24x24 36.00 / 18000 31.25 / 15625	(2) 20x24 (8) 24x24 38.67 / 19335 33.13 / 16565	(10) 24x24 (8) 24x24 40.00 / 20000 35.00 / 17500	(10) 20x24 (2) 24x24 41.33 / 20665 36.88 / 18440	(6) 20x24 (6) 24x24 44.00 / 22000 38.75 / 19375
60	FH48	(6) 20x24 (2) 24x24 28.00 / 14000 25.33 / 12665	(4) 20x24 (4) 24x24 29.33 / 14665 27.33 / 13665	(8) 24x24 32.00 / 16000 29.33 / 14665	(4) 20x24 (2) 24x24 34.67 / 17335 31.33 / 15665	(6) 20x24 (4) 24x24 36.00 / 18000 33.33 / 16665	(2) 20x24 (8) 24x24 38.67 / 19335 35.33 / 17665	(10) 24x24 (8) 24x24 40.00 / 20000 37.33 / 18665	(10) 20x24 (2) 24x24 41.33 / 20665 39.33 / 19665	(6) 20x24 (6) 24x24 44.00 / 22000 41.33 / 20665
66	FH54	(6) 20x24 (2) 24x24 28.00 / 14000 28.50 / 14250	(2) 20x24 (6) 24x24 30.67 / 15335 30.75 / 15375	(8) 24x24 32.00 / 16000 33.00 / 16500	(8) 20x24 (2) 24x24 34.67 / 17335 35.25 / 17625	(6) 20x24 (4) 24x24 36.00 / 18000 37.50 / 18750	(2) 20x24 (8) 24x24 38.67 / 19335 39.75 / 19875	(10) 24x24 (8) 24x24 40.00 / 20000 42.00 / 21000	(10) 20x24 (2) 24x24 41.33 / 20665 44.25 / 22125	(6) 20x24 (6) 24x24 44.00 / 22000 46.50 / 23250
73	FH(2)30	(9) 20x20 (3) 20x24 35.00 / 17500 31.67 / 15835	(3) 20x20 (9) 20x24 38.33 / 19165 34.17 / 17085	(12) 20x24 40.00 / 20000 36.67 / 18335	(12) 20x20 (3) 20x24 43.33 / 21665 39.17 / 19585	(9) 20x20 (6) 20x24 45.00 / 22500 41.67 / 20835	(3) 20x20 (12) 20x24 48.30 / 24150 44.17 / 22085	(15) 20x24 (10) 20x24 50.00 / 25000 46.67 / 23335	(12) 20x20 (6) 20x24 53.33 / 26665 49.17 / 24585	(9) 20x20 (9) 20x24 55.00 / 27500 51.67 / 25835
81	FH(2)33	(9) 20x24 (3) 24x24 42.00 / 21000 34.83 / 17415	(3) 20x24 (9) 24x24 46.00 / 23000 37.58 / 18790	(12) 24x24 48.00 / 24000 40.33 / 20165	(12) 20x24 (3) 24x24 52.00 / 26000 43.08 / 21540	(9) 20x24 (6) 24x24 54.00 / 27000 45.83 / 22915	(3) 20x24 (12) 24x24 58.00 / 29000 48.58 / 24290	(15) 24x24 (12) 24x24 60.00 / 30000 51.33 / 25665	(12) 20x24 (6) 24x24 64.00 / 32000 54.08 / 27040	(9) 20x24 (9) 24x24 66.00 / 33000 56.83 / 28415
87	FH(2)36	(12) 20x24 40.00 / 20000 38.00 / 19000	(9) 20x24 (3) 24x24 42.00 / 21000 41.00 / 20500	(6) 20x24 (6) 24x24 44.00 / 22000 44.00 / 22000	(3) 20x24 (9) 24x24 46.00 / 23000 47.00 / 23500	(9) 20x24 (6) 24x24 54.00 / 27000 50.00 / 25000	(6) 20x24 (9) 24x24 56.00 / 28000 53.00 / 26500	(15) 24x24 (10) 20x24 60.00 / 30000 56.00 / 28000	(12) 20x24 (6) 24x24 64.00 / 32000 59.00 / 29500	
93	FH(2)39	(12) 20x20 (4) 20x24 46.67 / 23335 41.17 / 20585	(4) 20x20 (12) 20x24 51.11 / 25555 44.42 / 22210	(16) 20x24 53.33 / 26665 47.67 / 23835	(16) 20x20 (4) 20x24 57.78 / 28890 50.92 / 25460	(12) 20x20 (8) 20x24 60.00 / 30000 54.17 / 27085	(4) 20x20 (16) 20x24 64.44 / 32220 57.42 / 28710	(20) 20x24 66.67 / 33335 60.67 / 30335		
98	FH(2)42	(12) 20x20 (4) 20x24 46.67 / 23335 44.33 / 22165	(4) 20x20 (12) 20x24 51.11 / 25555 47.83 / 23915	(16) 20x24 53.33 / 26665 51.33 / 25665	(16) 20x20 (4) 20x24 57.78 / 28890 54.83 / 27415	(12) 20x20 (8) 20x24 60.00 / 30000 58.33 / 29165	(4) 20x20 (16) 20x24 64.44 / 32220 61.83 / 30915			
111	FH(2)48		(4) 20x24 (12) 24x24 61.33 / 30665 54.67 / 27335	(16) 24x24 64.00 / 32000 58.67 / 29335	(16) 20x24 (4) 24x24 69.33 / 34665 62.67 / 31335					

Based on 5" unit base and 2" double wall and roof construction.

T Series Unit Dimensions • Flat Filter and Coil Selection Table

										METRIC	
Cabinet	UW	762	914	1067	1219	1372	1524	1676	1829	1981	2134
UH	Coil	FL406	FL559	FL711	FL864	FL1016	FL1168	FL1321	FL1473	FL1626	FL1778
711	FH381	(1) 305x610	(1) 305x610	(1) 305x610	(1) 305x610	(2) 305x610	(2) 305x610	(2) 305x610	(2) 305x610		
		0.19 / 1737	0.19 / 1737	0.19 / 1737	0.19 / 1737	0.37 / 3383	0.37 / 3383	0.37 / 3383	0.37 / 3383		
838	FH533	(1) 508x610	(1) 508x610	(1) 508x610	(2) 508x508	(2) 508x610	(2) 508x610	(3) 508x508	(3) 508x508	(3) 508x610	(4) 508x508
		0.31 / 2835	0.31 / 2835	0.31 / 2835	0.52 / 4755	0.62 / 5669	0.62 / 5669	0.77 / 7041	0.77 / 7041	0.93 / 8504	1.03 / 9418
940	FH610	(1) 610x610	(1) 305x610 (1) 508x610	(2) 508x610	(2) 610x610	(1) 305x610 (2) 508x610	(1) 305x610 (2) 610x610	(2) 508x610 (1) 610x610	(3) 610x610	(4) 508x610	
		0.37 / 3383	0.46 / 4206	0.62 / 5669	0.74 / 6767	0.81 / 7407	0.93 / 8504	0.99 / 9053	1.12 / 10241	1.24 / 11339	
991	FH686	(1) 610x610	(1) 305x610 (1) 610x610	(2) 508x610	(2) 610x610	(1) 305x610 (2) 508x610	(1) 305x610 (2) 610x610	(2) 508x610 (1) 610x610	(3) 610x610	(4) 508x610	
		0.37 / 3383	0.56 / 5121	0.62 / 5669	0.74 / 6767	0.81 / 7407	0.93 / 8504	0.99 / 9053	1.12 / 10241	1.24 / 11339	
1143	FH838	(1) 305x610 (1) 508x610	(1) 305x610 (1) 508x610	(2) 508x610	(2) 305x610 (2) 508x610	(2) 305x610 (2) 508x610	(2) 305x610 (2) 508x610	(2) 305x610 (2) 508x610	(3) 305x610 (3) 508x610	(3) 305x610 (3) 508x610	
		0.50 / 4572	0.50 / 4572	0.99 / 9053	0.99 / 9053	0.99 / 9053	0.99 / 9053	0.99 / 9053	0.99 / 9053	1.49 / 13625	1.49 / 13625
1270	FH991	(1) 305x610 (1) 610x610	(4) 508x508	(4) 508x610	(4) 508x610	(6) 508x508	(6) 508x508	(6) 508x508	(6) 508x610	(6) 508x610	
		0.56 / 5121	1.03 / 9418	1.24 / 11339	1.24 / 11339	1.55 / 14173	1.55 / 14173	1.86 / 17008	1.86 / 17008		
1346	FH1067	(1) 610x610	(4) 508x508	(4) 508x610	(4) 508x610	(6) 508x508	(6) 508x508	(6) 508x508	(6) 508x610	(8) 508x508	
		0.70 / 6401	0.86 / 7864	1.01 / 9235	1.16 / 10607	1.31 / 11979	1.46 / 13350	1.61 / 14722	1.76 / 16093		
1448	FH1143	(1) 305x610 (1) 610x610	(4) 508x508	(4) 508x610	(4) 508x610	(6) 508x508	(6) 508x508	(6) 508x508	(6) 508x610	(8) 508x508	
		0.56 / 5121	1.03 / 9418	1.24 / 11339	1.24 / 11339	1.55 / 14173	1.55 / 14173	1.86 / 17008	1.86 / 17008		
1524	FH1219	(1) 610x610	(4) 508x508	(4) 508x610	(4) 508x610	(6) 508x508	(6) 508x508	(6) 508x508	(6) 508x610	(8) 508x508	
		0.70 / 6401	0.86 / 7864	1.01 / 9235	1.16 / 10607	1.31 / 11979	1.46 / 13350	1.61 / 14722	1.76 / 16093		
1676	FH1372	(1) 305x610 (1) 610x610	(4) 508x508	(4) 508x610	(4) 508x610	(6) 508x508	(6) 508x508	(6) 508x508	(6) 508x610	(8) 508x508	
		0.56 / 5121	1.03 / 9418	1.24 / 11339	1.24 / 11339	1.55 / 14173	1.55 / 14173	1.86 / 17008	1.86 / 17008		
1854	FH(2)762	(1) 610x610	(4) 508x508	(4) 508x610	(4) 508x610	(6) 508x508	(6) 508x508	(6) 508x508	(6) 508x610	(8) 508x508	
		0.70 / 6401	0.86 / 7864	1.01 / 9235	1.16 / 10607	1.31 / 11979	1.46 / 13350	1.61 / 14722	1.76 / 16093		
2057	FH(2)838	(1) 305x610 (1) 610x610	(4) 508x508	(4) 508x610	(4) 508x610	(6) 508x508	(6) 508x508	(6) 508x508	(6) 508x610	(8) 508x508	
		0.56 / 5121	1.03 / 9418	1.24 / 11339	1.24 / 11339	1.55 / 14173	1.55 / 14173	1.86 / 17008	1.86 / 17008		
2210	FH(2)914	(1) 610x610	(4) 508x508	(4) 508x610	(4) 508x610	(6) 508x508	(6) 508x508	(6) 508x508	(6) 508x610	(8) 508x508	
		0.70 / 6401	0.86 / 7864	1.01 / 9235	1.16 / 10607	1.31 / 11979	1.46 / 13350	1.61 / 14722	1.76 / 16093		
2362	FH(2)991	(1) 305x610 (1) 610x610	(4) 508x508	(4) 508x610	(4) 508x610	(6) 508x508	(6) 508x508	(6) 508x508	(6) 508x610	(8) 508x508	
		0.56 / 5121	1.03 / 9418	1.24 / 11339	1.24 / 11339	1.55 / 14173	1.55 / 14173	1.86 / 17008	1.86 / 17008		
2489	FH(2)1067	(1) 610x610	(4) 508x508	(4) 508x610	(4) 508x610	(6) 508x508	(6) 508x508	(6) 508x508	(6) 508x610	(8) 508x508	
		0.70 / 6401	0.86 / 7864	1.01 / 9235	1.16 / 10607	1.31 / 11979	1.46 / 13350	1.61 / 14722	1.76 / 16093		
2819	FH(2)1219	(1) 305x610 (1) 610x610	(4) 508x508	(4) 508x610	(4) 508x610	(6) 508x508	(6) 508x508	(6) 508x508	(6) 508x610	(8) 508x508	
		0.56 / 5121	1.03 / 9418	1.24 / 11339	1.24 / 11339	1.55 / 14173	1.55 / 14173	1.86 / 17008	1.86 / 17008		

**LEGEND**

UH = Cabinet Height (inches)  
 UW = Cabinet Width (inches)  
 FH = Coil Fin Height (inches)  
 FL = Coil Fin Length (inches)  
 Coil Face Area : (Qty) FH x FL  
 Filter Face Area: (Qty) H x W  
 Example:

(1) 305x610 Filter (Qty) H x W

Filter 0.19/472 Face Area (Ft<sup>2</sup>)/Q (CFM)  
 Coil 0.16/393 Face Area (Ft<sup>2</sup>)/Q (CFM)  
 Calculations are based on 500 FPM velocity

Based on 127 mm unit base and 51 mm double wall and roof construction.



**T Series Unit Dimensions • Flat Filter and Coil Selection Table**

**METRIC**

Cabinet	UW	2286	2438	2591	2743	2896	3048	3200	3353	3505
UH	Coil	FL1930	FL2083	FL2235	FL2388	FL2540	FL2692	FL2845	FL2997	FL3150
711	FH381	<p><b>LEGEND</b>            UH = Cabinet Height (inches)            UW = Cabinet Width (inches)            FH = Coil Fin Height (inches)            FL = Coil Fin Length (inches)            Coil Face Area : (Qty) FH x FL            Filter Face Area: (Qty) H x W            Example:            Filter <b>(1) 305 x 610</b> Face Area (Ft<sup>2</sup>)/Q (CFM)                      <b>(3) 610 x 610</b> Face Area (Ft<sup>2</sup>)/Q (CFM)            Coil <b>1.30 / 3304</b> Face Area (Ft<sup>2</sup>)/Q (CFM)            Calculations are based on 500 FPM velocity</p>								
838	FH533									
940	FH610	(1) 305x610 3.30 / 11887 1.33 / 10790	(2) 508x610 (2) 610x610 1.36 / 12436 1.27 / 11613							
991	FH686	(1) 305x610 (3) 610x610 1.30 / 11887	(2) 508x610 (2) 610x610 1.36 / 12436	(4) 610x610 1.49 / 13625						
1143	FH838	(3) 305x610 (3) 508x610 1.49 / 13625	(3) 305x610 (3) 508x610 1.49 / 13625	(4) 305x610 (4) 508x610 1.98 / 18105	(4) 305x610 (4) 508x610 1.98 / 18105	(4) 305x610 (4) 508x610 1.98 / 18105	(4) 305x610 (4) 508x610 1.98 / 18105			
1270	FH991	(8) 508x508 2.06 / 18837 1.91 / 17465	(4) 508x508 (4) 508x610 2.27 / 20757 2.07 / 18928	(8) 508x610 2.48 / 22677	(10) 508x508 2.58 / 23592	(6) 508x508 (4) 508x610 2.79 / 25512	(4) 508x508 (6) 508x610 2.89 / 26426	(12) 508x508 3.10 / 28346	(10) 508x508 (2) 508x610 3.20 / 29261	
1346	FH1067	(8) 508x508 2.07 / 18928 2.06 / 18837	(4) 508x508 (4) 508x610 2.27 / 20757 2.22 / 20300	(8) 508x610 2.48 / 22769	(10) 508x508 2.58 / 23592	(6) 508x508 (4) 508x610 2.79 / 25512	(4) 508x508 (6) 508x610 2.89 / 26426	(12) 508x508 3.10 / 28346	(8) 508x508 (4) 508x610 3.31 / 30267	(6) 508x610 3.41 / 31181
1448	FH1143	(6) 508x610 (2) 610x610 2.60 / 23774	(4) 508x610 (4) 610x610 2.73 / 24963	(8) 610x610 2.98 / 27249	(8) 508x610 (2) 610x610 3.22 / 29444	(6) 508x610 (4) 610x610 3.35 / 30632	(2) 508x610 (8) 610x610 3.60 / 32918	(10) 610x610 3.72 / 34016	(10) 508x610 (2) 610x610 3.84 / 35113	(6) 508x610 (6) 610x610 4.10 / 37490
1524	FH1219	(6) 508x610 (2) 610x610 2.60 / 23774	(4) 508x610 (4) 610x610 2.73 / 24963	(8) 610x610 2.98 / 27249	(8) 508x610 (2) 610x610 3.22 / 29444	(6) 508x610 (4) 610x610 3.35 / 30632	(2) 508x610 (8) 610x610 3.60 / 32918	(10) 610x610 3.72 / 34016	(10) 508x610 (2) 610x610 3.84 / 35113	(6) 508x610 (6) 610x610 4.10 / 37490
1676	FH1372	(6) 508x610 (2) 610x610 2.60 / 23774	(4) 508x610 (6) 610x610 2.85 / 26060	(8) 610x610 2.98 / 27249	(8) 508x610 (2) 610x610 3.22 / 29444	(6) 508x610 (4) 610x610 3.35 / 30632	(2) 508x610 (6) 610x610 3.47 / 31730	(10) 610x610 3.72 / 34016	(10) 508x610 (2) 610x610 3.84 / 35113	(6) 508x610 (6) 610x610 4.10 / 37490
1854	FH(2)762	(9) 508x508 (3) 508x610 3.26 / 29809	(3) 508x508 (9) 508x610 3.56 / 32553	(12) 508x610 3.72 / 34016	(12) 508x508 (3) 508x610 4.03 / 36850	(9) 508x508 (6) 508x610 4.19 / 38313	(3) 508x508 (12) 508x610 4.49 / 41057	(15) 508x610 4.65 / 42520	(12) 508x508 (6) 508x610 4.96 / 45354	(9) 508x508 (9) 508x610 5.12 / 46817
2057	FH(2)838	(9) 508x610 (3) 610x610 3.91 / 35753	(3) 508x610 (9) 610x610 4.28 / 39136	(12) 610x610 4.46 / 40782	(12) 508x610 (3) 610x610 4.84 / 44257	(9) 508x610 (6) 610x610 5.02 / 45903	(3) 508x610 (12) 610x610 5.39 / 49286	(15) 610x610 5.58 / 51024	(12) 508x610 (6) 610x610 5.95 / 54407	(9) 508x610 (9) 610x610 6.14 / 56144
2210	FH(2)914	(12) 508x610 3.72 / 34016 3.53 / 32278	(9) 508x610 (3) 610x610 3.91 / 35753	(6) 508x610 (6) 610x610 4.09 / 37399	(3) 508x610 (9) 610x610 4.28 / 39136	(9) 508x610 (6) 610x610 5.02 / 45902	(6) 508x610 (9) 610x610 5.21 / 47640	(15) 610x610 5.58 / 51024	(12) 508x610 (6) 610x610 5.95 / 54407	(9) 508x610 (9) 610x610 6.14 / 56144
2362	FH(2)991	(12) 508x508 (4) 508x610 4.34 / 39685	(4) 508x508 (12) 508x610 4.75 / 43434	(16) 508x610 4.96 / 45354	(16) 508x508 (4) 508x610 5.37 / 49103	(12) 508x508 (8) 508x610 5.58 / 51024	(4) 508x508 (16) 508x610 5.99 / 54773	(20) 508x610 6.20 / 56693		
2489	FH(2)1067	(12) 508x508 (4) 508x610 4.34 / 39685	(4) 508x508 (12) 508x610 4.75 / 43434	(16) 508x610 4.96 / 45354	(16) 508x508 (4) 508x610 5.37 / 49103	(12) 508x508 (8) 508x610 5.58 / 51024	(4) 508x508 (16) 508x610 5.99 / 54773			
2819	FH(2)1219		(4) 508x610 (12) 610x610 5.70 / 52121	(16) 610x610 5.95 / 54407	(16) 508x610 (4) 610x610 6.45 / 58979					
			5.08 / 46452	5.47 / 50018	5.83 / 53310					

Based on 127 mm unit Base and 51 mm double wall and Roof construction.

**Notes:**

# Component Selection:

## Fans, Filters, Mixing Box & Coil



## Fan Selection

### Forward Curved

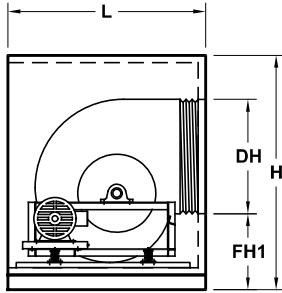

THD-CW (Top Horizontal)

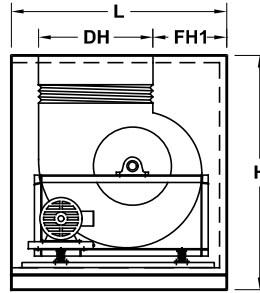

UBD-CW (Up Discharge)

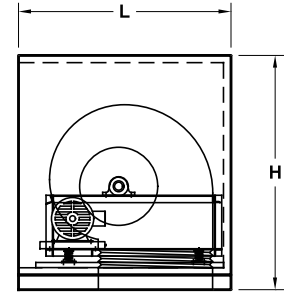

DBD-CW (Down Discharge)

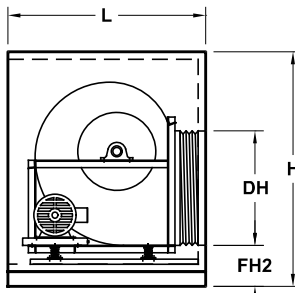

BHD-CCW (Bottom Horizontal)

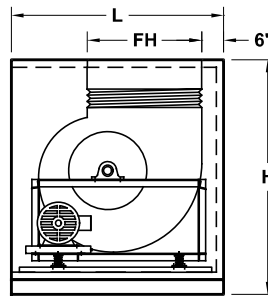

UBD-CCW (Up Discharge)

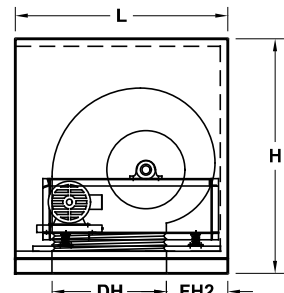

DBD-CCW (Down Discharge)

#### Imperial (inch)

FC FAN SIZE	Minimum Dimensions				DH	FH1	FH2*		Blow Through Diffuser Section L1
	H*		L				1"	2"	
	1"	2"	Behind	Beside					
9	29	31	36	CF**	10 5/8	22 5/8	11	-	10
10	31	33	38	CF**	11 7/8	22 5/8	11	-	10
12	34	36	40	CF**	13 7/8	24 7/8	11	-	11
15	38	39	46	CF**	16 1/4	25	11	12 3/4	13
18	43	44	53	48	19 5/16	26 1/4	11	12 3/4	14
20	49	51	59	48	22 5/16	27 1/8	11	12 3/4	16
22	53	55	62	48	24 1/8	29	11	12 3/4	17
25	58	60	70	52	27 7/16	30 1/2	11	12 3/4	18
28	63	65	75	52	29 13/16	32 1/8	11	12 3/4	19
30	67	69	78	55	32 1/2	36 1/2	11	12 3/4	21

\* Listed as 1" or 2" spring deflection

\*\* Contact Factor

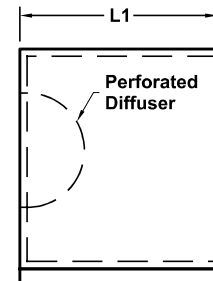

Blow Through Diffuser Section

#### Metric (mm)

FC FAN SIZE	Minimum Dimensions				DH	FH1	FH2*		Blow Through Diffuser Section L1
	H*		L				25.4	50.8	
	25.4	50.8	Behind	Beside					
228.6	736.6	787.4	914.4	CF**	269.9	574.7	279.4	-	236.5
254.0	787.4	838.2	965.2	CF**	301.6	574.7	279.4	-	252.4
304.8	863.6	914.4	1016.0	CF**	352.4	631.8	279.4	-	277.8
381.0	965.2	990.6	1168.4	CF**	412.8	635.0	279.4	323.9	308.0
457.2	1092	1117.6	1346.2	1219.2	490.5	666.8	279.4	323.9	346.9
508.0	1244.6	1295.4	1498.6	1219.2	566.7	689.0	279.4	323.9	385.0
558.8	1346.2	1397.0	1574.8	1219.2	612.8	736.6	279.4	323.9	408.0
635.0	1473.2	1524.0	1778.0	1320.8	696.9	774.7	279.4	323.9	450.1
711.2	1600.2	1651.0	1905.0	1320.8	757.2	816.0	279.4	323.9	480.2
762.0	1701.8	1752.6	1981.2	1397.0	825.5	927.1	279.4	323.9	514.4

\* Listed as 25.4 mm or 50.8 mm spring deflection

\*\* Contact Factor



# Fan Selection

## Forward Curved

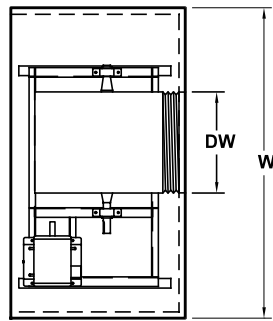

Motor Beside

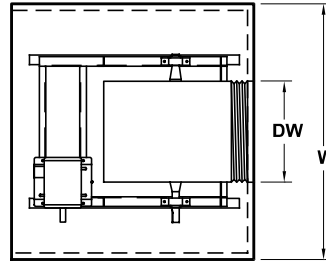

Motor Behind

Imperial (inch)

FC FAN SIZE	Minimum Width Motor Beside								Minimum Width Motor Behind	DW
	143T	182T	213T	254T	284T	324T	364T	404T		
9	CONTACT FACTORY								43	12 3/16
10									44	13 3/8
12									47	15 1/4
15									50	17 5/8
18	65	65	71	77	-	-	-	-	53	21 5/16
20	71	71	77	77	83	-	-	-	64	24 1/4
22	71	71	77	83	83	89	-	-	67	26 9/16
25	77	77	83	83	89	89	-	-	71	30 1/2
28	-	83	83	89	89	95	95	-	74	33 7/16
30	-	-	89	89	95	95	101	107	76	36 1/8

Motor Chart	
Frame	HP (kW)
143T	1 (0.75)
145T	1.5 (1.12)
145T	2 (1.49)
182T	3 (2.24)
184T	5 (3.73)
213T	7.5 (5.6)
215T	10 (7.46)
254T	15 (11.19)
256T	20 (14.92)
284T	25 (18.65)
286T	30 (22.38)
324T	40 (29.84)
326T	50 (37.30)
364T	60 (44.76)
365T	75 (55.95)
404T	100 (74.60)

Metric (mm)

FC FAN SIZE	Minimum Width Motor Beside								Minimum Width Motor Behind	DW
	143T	182T	213T	254T	284T	324T	364T	404T		
228.6	CONTACT FACTORY								1092.2	12 3/16
254.0									1117.6	13 3/8
304.8									1193.8	15 1/4
381.0									1270.0	17 5/8
457.2	1651.0	1651.0	1803.4	1955.8	-	-	-	-	1346.2	21 5/16
508.0	1803.4	1803.4	1955.8	1955.8	2108.2	-	-	-	1625.6	24 1/4
558.8	1803.4	1803.4	1955.8	2108.2	2108.2	2260.6	-	-	1701.8	26 9/16
635.0	1955.8	1955.8	2108.2	2108.2	2260.6	2260.6	-	-	1803.4	30 1/2
711.2	-	2108.2	2108.2	2260.6	2260.6	2413.0	2413.0	-	1879.6	33 7/16
762.0	-	-	2260.6	2260.6	2413.0	2413.0	2565.4	2717.8	1930.4	36 1/8

# Fan Selection

## Airfoil

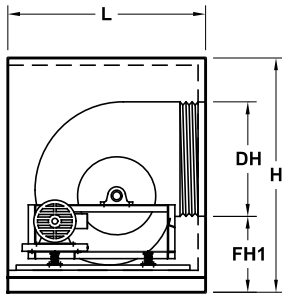

THD-CW (Top Horizontal)

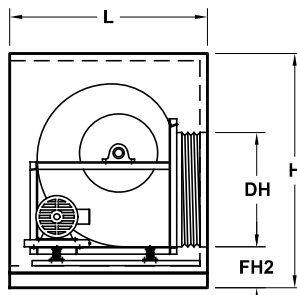

BHD-CCW (Bottom Horizontal)

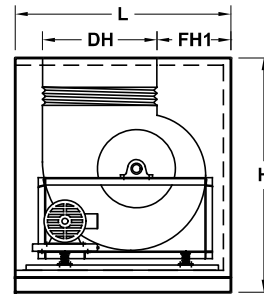

UBD-CW (Up Discharge)

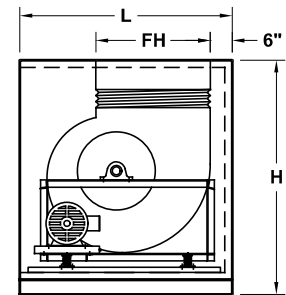

UBD-CCW (Up Discharge)

Imperial (inch)

AF FAN SIZE	Minimum Dimensions				DH	FH1	FH2*		Blow Through Diffuser Section L1
	H*		L				1"	2"	
	1"	2"	Behind	Beside					
10	35	36	40	-	11 1/8	22 5/8	12	-	10
12	39	41	46	-	13 5/8	22 5/8	12	-	11
13	41	43	52	-	15 1/8	24 7/8	12	-	12
15	44	46	54	-	16 3/4	25	12	-	13
16	47	49	57	-	18 1/2	26 1/4	12	-	14
18	50	52	64	52	20 1/2	27 1/8	12	12 3/4	15
20	54	56	67	52	22 1/2	27 1/8	12	12 3/4	16
22	58	60	73	58	24 7/8	29	12	12 3/4	17
24	62	64	77	59	27 3/8	30 1/2	12	12 3/4	18
27	67	69	80	59	30 1/4	32 1/8	12	14 3/4	20
30	75	75	88	63	33 1/2	34	12	14 3/4	21
33	80	80	92	66	36 7/8	36 1/2	12	14 3/4	23
36	87	87	99	74	40 3/4	39 1/8	12	14 3/4	25
40	94	94	109	80	44 7/8	41 5/8	12	14 3/4	27
44	102	102	114	87	49 5/8	44 7/8	12	14 3/4	29

\* Listed as 1" or 2" spring deflection

Metric (mm)

AF FAN SIZE	Minimum Dimensions				DH	FH1	FH2*		Blow Through Diffuser Section L1
	H*		L				25.4	50.8	
	25.4	50.8	Behind	Beside					
254.0	889.0	914.4	1016.0	-	282.6	574.7	304.8	-	254.0
304.8	990.6	1041.4	1168.4	-	346.1	574.7	304.8	-	279.4
330.2	1041.4	1092.2	1320.8	-	384.2	631.8	304.8	-	304.8
381.0	1117.6	1168.4	1371.6	-	425.5	635.0	304.8	-	330.2
406.4	1193.8	1244.6	1447.8	-	469.9	666.8	304.8	-	355.6
457.2	1270.0	1320.8	1625.6	1320.8	520.7	689.0	304.8	323.9	381.0
508.0	1371.6	1422.4	1701.8	1320.8	571.5	689.0	304.8	323.9	406.4
558.8	1473.2	1524.0	1854.2	1473.2	631.8	736.6	304.8	323.9	431.8
609.6	1574.8	1625.6	1955.8	1498.6	695.3	774.7	304.8	323.9	457.2
685.8	1701.8	1752.6	2032.0	1498.6	768.4	816.0	304.8	374.7	508.0
762.0	1905.0	1905.0	2235.2	1600.2	850.9	863.6	304.8	374.7	533.4
838.2	2032.0	2032.0	2336.8	1676.4	936.6	927.1	304.8	374.7	584.2
914.4	2209.8	2209.8	2514.6	1879.6	1035.1	993.8	304.8	374.7	635.0
1016.0	2387.6	2387.6	2768.6	2032.0	1139.8	1057.3	304.8	374.7	685.8
1117.6	2590.8	2590.8	2895.6	2209.8	1260.5	1139.8	304.8	374.7	736.6

\* Listed as 25.4mm or 50.8mm spring deflection

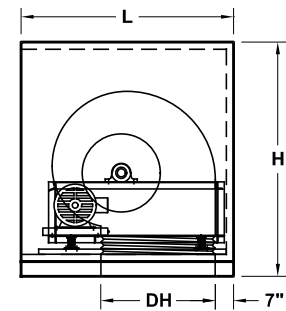

DBD-CW (Down Discharge)

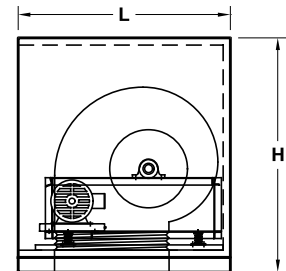

DBD-CCW (Down Discharge)

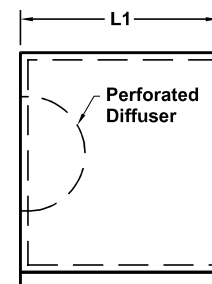

Blow Through Diffuser Section

# Fan Selection

## Airfoil

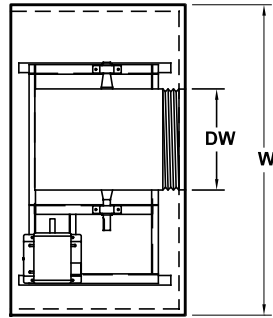

Motor Beside

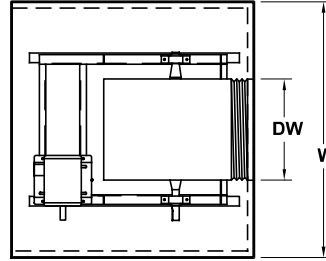

Motor Behind

Imperial (inch)

FC FAN SIZE	Minimum Width Motor Beside								Minimum Width Motor Behind	DW
	143T	182T	213T	254T	284T	324T	364T	404T		
	145T	184T	215T	256T	286T	326T	365T	& UP		
10	CONTACT FACTORY								45	13 5/8
12									48	16 5/8
13									52	18 3/4
15									54	20 1/4
16									57	22 1/4
18	70	72	75	81	-	-	-	-	64	24 3/4
20	71	74	77	83	-	-	-	-	66	27
22	75	77	80	86	-	-	-	-	70	30 1/8
24	77	77	83	89	89	-	-	-	73	33 1/4
27	81	83	86	92	94	-	-	-	76	36 1/2
30	85	87	90	96	98	102	-	-	80	40 1/2
33	90	92	95	101	103	107	109	-	84	44 5/8
36	94	96	99	105	107	111	113	-	89	49 1/4
40	99	101	104	110	112	116	118	121	94	54 3/8
44	105	107	110	116	118	122	124	128	99	60

Motor Chart	
Frame	HP (kW)
143T	1 (0.75)
145T	1.5 (1.12)
145T	2 (1.49)
182T	3 (2.24)
184T	5 (3.73)
213T	7.5 (5.6)
215T	10 (7.46)
254T	15 (11.19)
256T	20 (14.92)
284T	25 (18.65)
286T	30 (22.38)
324T	40 (29.84)
326T	50 (37.30)
364T	60 (44.76)
365T	75 (55.95)
404T	100 (74.60)

Metric (mm)

FC FAN SIZE	Minimum Width Motor Beside								Minimum Width Motor Behind	DW
	143T	182T	213T	254T	284T	324T	364T	404T		
	145T	184T	215T	256T	286T	326T	365T	& UP		
254.0	CONTACT FACTORY								1143.0	346.1
304.8									1219.2	422.3
330.2									1320.8	476.3
381.0									1371.6	514.4
406.4									1447.8	565.2
457.2	1778.0	1828.8	1905.0	2057.4	-	-	-	-	1625.6	628.7
508.0	1803.4	1879.6	1955.8	2108.2	-	-	-	-	1676.4	685.8
558.8	1905.0	1955.8	2032.0	2184.4	-	-	-	-	1778.0	765.2
609.6	1955.8	1955.8	2108.2	2260.6	2260.6	-	-	-	1854.2	844.6
685.8	2057.4	2108.2	2184.4	2336.8	2387.6	-	-	-	1930.4	927.1
762.0	2159.0	2209.8	2286.0	2438.4	2489.2	2590.8	-	-	2032.0	1028.7
838.2	2286.0	2336.8	2413.0	2565.4	2616.2	2717.8	2768.6	-	2133.6	1133.5
914.4	2387.6	2438.4	2514.6	2667.0	2717.8	2819.4	2870.2	-	2260.6	1251.0
1016.0	2514.6	2565.4	2641.6	2794.0	2844.8	2946.4	2997.2	3073.4	2387.6	1381.1
1117.6	2667.0	2717.8	2794.0	2946.4	2997.2	3098.8	3149.6	3251.2	2514.6	1524.0

# Fan Selection

## Plenum • Motor Beside Configuration

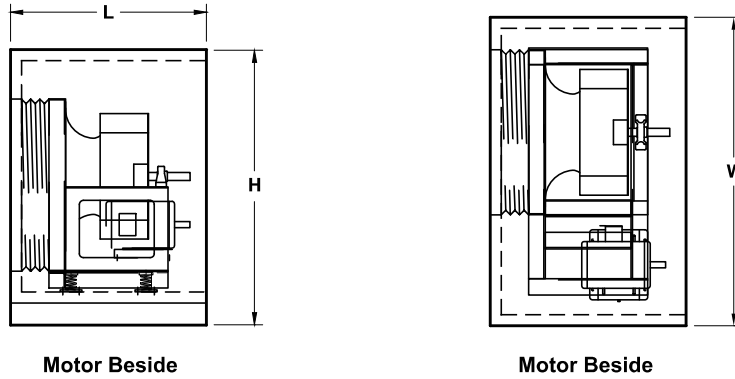

Imperial (inch)

PLENUM FAN SIZE	Minimum Dimensions			Minimum Width Motor Beside						
	H*		L	143T	182T	213T	254T	284T	324T	364T
	1"	2"	Beside	145T	184T	215T	256T	286T	326T	365T
123	CONTACT FACTORY									
133										
153										
163										
183	39	41	37	58	60	62	-	-	-	-
203	40	42	37	59	61	63	67	-	-	-
223	44	46	38	63	65	67	71	-	-	-
243	47	49	40	66	68	70	74	-	-	-
273	50	52	43	69	71	73	77	82	-	-
303	53	55	46	79	81	83	87	92	-	-
333	57	59	44	83	85	87	91	96	-	-
363	61	63	47	87	89	91	95	100	103	-
403	65	67	49	91	93	95	99	104	107	-
443	73	75	55	-	101	103	107	112	115	-
493	80	81	-	-	-	-	-	-	-	-

\* Listed as 1" or 2" spring deflection

Motor Chart	
Frame	HP (kW)
143T	1 (0.75)
145T	1.5 (1.12)
182T	2 (1.49)
184T	3 (2.24)
213T	5 (3.73)
215T	7.5 (5.6)
254T	10 (7.46)
256T	15 (11.19)
284T	20 (14.92)
286T	25 (18.65)
324T	30 (22.38)
326T	40 (29.84)
364T	50 (37.30)
365T	60 (44.76)
404T	75 (55.95)
404T	100 (74.60)

Metric (mm)

PLENUM FAN SIZE	Minimum Dimensions			Minimum Width Motor Beside						
	H*		L	143T	182T	213T	254T	284T	324T	364T
	25.4	50.8	Beside	145T	184T	215T	256T	286T	326T	365T
123	CONTACT FACTORY									
133										
153										
163										
183	990.6	1041.4	939.8	1473.2	1524.0	1574.8	-	-	-	-
203	1016.0	1066.8	939.8	1498.6	1549.4	1600.2	1701.8	-	-	-
223	1117.6	1168.4	965.2	1600.2	1651.0	1701.8	1803.4	-	-	-
243	1193.8	1244.6	1016.0	1676.4	1727.2	1778.0	1879.6	-	-	-
273	1270.0	1320.8	1092.2	1752.6	1803.4	1854.2	1955.8	2082.8	-	-
303	1346.2	1397.0	1168.4	2006.6	2057.4	2108.2	2209.8	2336.8	-	-
333	1447.8	1498.6	1117.6	2108.2	2159.0	2209.8	2311.4	2438.4	-	-
363	1549.4	1600.2	1193.8	2209.8	2260.6	2311.4	2413.0	2540.0	2616.2	-
403	1651.0	1701.8	1244.6	2311.4	2362.2	2413.0	2514.6	2641.6	2717.8	-
443	1854.2	1905.0	1397.0	-	2565.4	2616.2	2717.8	2844.8	2921.0	-
493	2032.0	2057.4	-	-	-	-	-	-	-	-

\* Listed as 25.4mm or 50.8mm spring deflection

# Fan Selection

## Plenum • Motor Behind Configuration

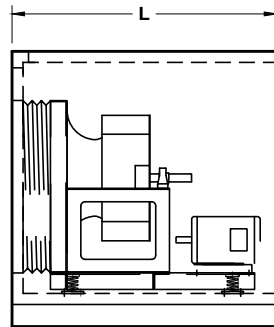

Motor Behind

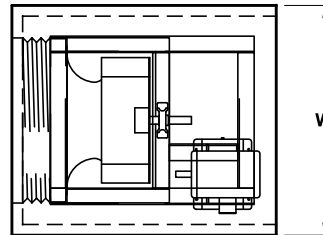

Motor Behind

Imperial (inch)

PLENUM FAN SIZE	Minimum Dimensions			Minimum Width Motor Beside						
	H*		L	143T	182T	213T	254T	284T	324T	364T
	1"	2"	Behind	145T	184T	215T	256T	286T	326T	365T
123	CONTACT FACTORY									
133										
153										
163										
183	39	41	45	48	53	58	-	-	-	-
203	40	42	50	50	53	58	63	-	-	-
223	44	46	52	51	55	59	65	-	-	-
243	47	49	56	54	54	60	66	-	-	-
273	50	52	60	57	57	61	66	71	-	-
303	53	55	62	73	73	73	80	85	-	-
333	57	59	65	77	77	77	80	86	-	-
363	61	63	70	81	81	81	81	86	92	-
403	65	67	72	85	85	85	85	87	93	-
443	73	75	78	-	93	93	93	93	94	-
493	80	81	83	-	-	99	99	99	99	101

Motor Chart	
Frame	HP (kW)
143T	1 (0.75)
145T	1.5 (1.12)
145T	2 (1.49)
182T	3 (2.24)
184T	5 (3.73)
213T	7.5 (5.6)
215T	10 (7.46)
254T	15 (11.19)
256T	20 (14.92)
284T	25 (18.65)
286T	30 (22.38)
324T	40 (29.84)
326T	50 (37.30)
364T	60 (44.76)
365T	75 (55.95)
404T	100 (74.60)

\* Listed as 1" or 2" spring deflection

Metric (mm)

PLENUM FAN SIZE	Minimum Dimensions			Minimum Width Motor Beside						
	H*		L	143T	182T	213T	254T	284T	324T	364T
	25.4	50.8	Behind	145T	184T	215T	256T	286T	326T	365T
123	CONTACT FACTORY									
133										
153										
163										
183	990.6	1041.4	1143.0	1219.2	1346.2	1473.2	-	-	-	-
203	1016.0	1066.8	1270.0	1270.0	1346.2	1473.2	1600.2	-	-	-
223	1117.6	1168.4	1320.8	1295.4	1397.0	1498.6	1651.0	-	-	-
243	1193.8	1244.6	1422.4	1371.6	1371.6	1524.0	1676.4	-	-	-
273	1270.0	1320.8	1524.0	1447.8	1447.8	1549.4	1676.4	1803.4	-	-
303	1346.2	1397.0	1574.8	1854.2	1854.2	1854.2	2032.0	2159.0	-	-
333	1447.8	1498.6	1651.0	1955.8	1955.8	1955.8	2032.0	2184.4	-	-
363	1549.4	1600.2	1778.0	2057.4	2057.4	2057.4	2057.4	2184.4	2336.8	-
403	1651.0	1701.8	1828.8	2159.0	2159.0	2159.0	2159.0	2209.8	2362.2	-
443	1854.2	1905.0	1981.2	-	2362.2	2362.2	2362.2	2362.2	2387.6	-
493	2032.0	2057.4	2108.2	-	-	2514.6	2514.6	2514.6	2514.6	2565

\* Listed as 25.4mm or 50.8mm spring deflection



## Filter Selection



**Flat Filter Section**

Filter Depth inch (mm)	FL inch (mm)
2 (50.8)	12 (304.8)
4 (101.6)	12 (304.8)
12 (304.8)	18 (457.2)
21 (533.4)	24 (609.6)

**Notes:**

1. Must be selected @ <500FPM (2.54 m/s).
2. Add 6" (152.4 mm) to FL if this section is the first or last section in the air handler.
3. Requires Header Track

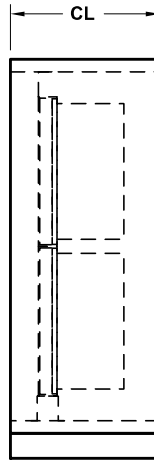

**Combination Filter Section**

Pre-Filter Depth inch (mm)	Final Filter Depth inch (mm)	CL inch (mm)
2 (50.8)	4 (101.6)	14 (355.6)
	6 (152.4)	16 (406.4)
	12 (304.8)	20 (508.0)
	21 (533.4)	26 (660.4)
4 (101.6)	4 (101.6)	14 (355.6)
	6 (152.4)	16 (406.4)
	12 (304.8)	20 (508.0)
	21 (533.4)	26 (660.4)

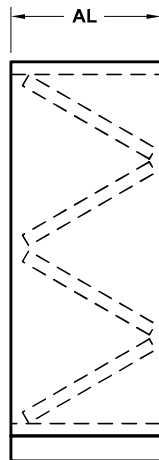

**Fangle Filter Section**

AL inch (mm)
24 (609.6)

**Notes:**

1. Available with 2" (50.8 mm) or 4" (101.6 mm) pleated filters.
2. Add 6" (152.4 mm) to AL if this section is the first or last section in the air handler.
3. Contact factory for filter sizes.

Filter Size inch (mm)	Filter Type	Filter Efficiency	MERV Rating	Initial Resistance	Final Resistance	Recommended Resistance
				Velocity = 500 FPM (2.54 m/s)		
				in w.g. (KPa)		
2 (50.8)	Pleated	30%	MERV 7	0.28 (0.07)	1.00 (0.25)	0.64 (0.16)
		60%	MERV 11	0.31 (0.08)	1.00 (0.25)	0.66 (0.16)
4 (101.6)	Pleated	30%	MERV 7	0.23 (0.06)	1.00 (0.25)	0.62 (0.15)
		60%	MERV 11	0.25 (0.06)	1.00 (0.25)	0.63 (0.16)
12 (304.8)	Cartridge	40-45%	MERV 9	0.25 (0.06)	1.50 (0.37)	0.88 (0.22)
		60-65%	MERV 11	0.28 (0.07)	1.50 (0.37)	0.89 (0.22)
		80-85%	MERV 13	0.44 (0.11)	1.50 (0.37)	0.97 (0.24)
		90-95%	MERV 14	0.51 (0.13)	1.50 (0.37)	1.01 (0.25)
21 (533.4)	Bag	40-45%	MERV 9	0.30 (0.07)	1.00 (0.25)	0.65 (0.16)
		60-65%	MERV 11	0.36 (0.09)	1.00 (0.25)	0.68 (0.17)
		80-85%	MERV 13	0.43 (0.11)	1.00 (0.25)	0.72 (0.18)
		90-95%	MERV 14	0.52 (0.13)	1.00 (0.25)	0.76 (0.19)

## Mixing Selection

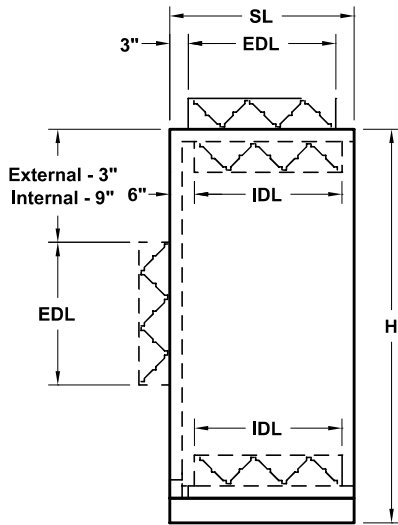

**SL = Section Length**  
**EDL = External Damper Length**  
**IDL = Internal Damper Length**

**Example:**

If EDL = 6", therefore  
SL = EDL + 6" = 12"  
If IDL = 6", therefore  
SL = IDL + 12" = 18"

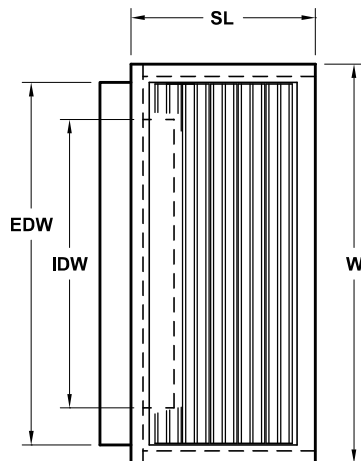

**SL = Section Length**  
**EDW = External Damper Width**  
**IDW = Internal Damper Width**

**Example:**

If Unit Width = 30", therefore  
EDW = W - 6" = 24"  
If W = 30", therefore  
IDW = W - 18" = 12"

**Note:**

Damper calculation is based on 2" double wall construction.

inches (mm)

DAMPER LENGTH			
External Damper		Internal Damper	
SL	EDL	SL	IDL
12 (304.8)	6 (152.4)	18 (457.2)	6 (152.4)
18 (457.2)	12 (304.8)	24 (609.6)	12 (304.8)
18 (457.2)	12 (304.8)	24 (609.6)	12 (304.8)
24 (609.6)	18 (457.2)	30 (762.0)	18 (457.2)
24 (609.6)	18 (457.2)	36 (914.4)	24 (609.6)
30 (762.0)	24 (609.6)	36 (914.4)	24 (609.6)
30 (762.0)	24 (609.6)	42 (1066.8)	30 (762.0)
30 (762.0)	24 (609.6)	42 (1066.8)	30 (762.0)
36 (914.4)	30 (762.0)	42 (1066.8)	30 (762.0)
36 (914.4)	30 (762.0)	48 (1219.2)	36 (914.4)
42 (1066.8)	36 (914.4)	48 (1219.2)	36 (914.4)
42 (1066.8)	36 (914.4)	54 (1371.6)	42 (1066.8)
48 (1219.2)	42 (1066.8)	54 (1371.6)	42 (1066.8)
48 (1219.2)	42 (1066.8)	60 (1524.0)	48 (1219.2)
54 (1371.6)	48 (1219.2)	60 (1524.0)	54 (1371.6)

inches (mm)

Unit Width (W)	DAMPER WIDTH	
	EDW	IDW
30 (762.0)	24 (609.6)	12 (304.8)
36 (914.4)	30 (762.0)	18 (457.2)
42 (1066.8)	36 (914.4)	24 (609.6)
48 (1219.2)	42 (1066.8)	30 (762.0)
54 (1371.6)	48 (1219.2)	36 (914.4)
60 (1524.0)	54 (1371.6)	42 (1066.8)
66 (1676.4)	60 (1524.0)	48 (1219.2)
72 (1828.8)	66 (1676.4)	54 (1371.6)
78 (1981.2)	72 (1828.8)	60 (1524.0)
84 (2133.6)	78 (1981.2)	66 (1676.4)
90 (2286.0)	84 (2133.6)	72 (1828.8)
96 (2438.4)	90 (2286.0)	78 (1981.2)
102 (2590.8)	96 (2438.4)	84 (2133.6)
108 (2743.2)	102 (2590.8)	90 (2286.0)
114 (2895.6)	108 (2743.2)	96 (2438.4)
120 (3048.0)	114 (2895.6)	102 (2590.8)
126 (3200.4)	120 (3048.0)	108 (2743.2)
132 (3352.8)	126 (3200.4)	114 (2895.6)
138 (3505.2)	132 (3352.8)	120 (3048.0)
144 (3657.6)	138 (3505.2)	126 (3200.4)

**Standard Vee-Blade Damper Pressure Drop, in w.g. (KPa)**

Damper Size inch (mm)	Velocity, FPM (m/s)		
	1000 (5.08)	1500 (7.62)	2000 (10.16)
24 (609.6) x 24 (609.6)	0.11 (0.03)	0.24 (0.06)	0.47 (0.12)
36 (914.4) x 36 (914.4)	0.08 (0.02)	0.22 (0.05)	0.38 (0.09)

Values based on unducted damper mounting.

**Aluminum Airfoil Blade Damper Pressure Drop, in w.g. (KPa)**

Damper Size inch (mm)	Velocity, FPM (m/s)		
	1000 (5.08)	1500 (7.62)	2000 (10.16)
24 (609.6) x 24 (609.6)	0.13 (0.03)	0.19 (0.05)	0.31 (0.08)
36 (914.4) x 36 (914.4)	0.06 (0.02)	0.16 (0.04)	0.21 (0.05)

Values based on unducted damper mounting.

## Cooling Coil Selection

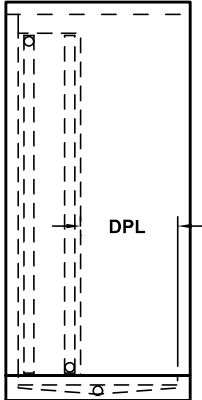

AIR VELOCITY FPM (m/s)	FPI (fpm*)	RECOMMENDED DRAIN PAN LENGTH <sup>1, 2</sup> "DPL"				
		inch (mm)				
		6 (152.4)	12 (304.8)	18 (457.2)	24 (609.6)	30 (762.0)
400 (2.03)	8 (315)	X				
	10 (394)	X				
	12 (472)	X	X			
450 (2.29)	14 (551)	X	X			
	8 (315)	X				
	10 (394)	X	X			
500 (2.54)	12 (472)	X	X			
	14 (551)	X	X	X		
	8 (315)	X	X			
550 (2.79)	10 (394)	X	X	X		
	12 (472)	X	X	X		
	8 (315)	X	X	X		
	10 (394)	X	X	X		
	12 (472)	X	X	X	X	

\* fin per meter

No. of Coil Rows	Coil Depth inch (mm)
1	6 (152.4)
2	7.5 (190.5)
4	7.5 (190.5)
6	10 (254.0)
8	12.5 (317.5)
10	15 (381.0)
12	18 (457.2)

**Note:**

1. Drain Pan Length table covers "Normal" wet-bulb conditions. Please consult Thermal Corporation when selecting coils for use in extreme conditions, such as 100% outside air or coils with heavy dehumidification loads.
2. Drain Pan Length table is based on 48" (1219.2 mm) fin height coil. Moisture carry over beyond the leaving edge of the coil is proportional to the fin height of the coil.

## Air Pressure Drop

### 5/8" (15.88 mm) Cooling Coil

FPI (fpm*)	Face Velocity - FPM (m/s)											
	450 (2.29)				500 (2.54)				550 (2.79)			
	6 Row	8 Row	10 Row	12 Row	6 Row	8 Row	10 Row	12 Row	6 Row	8 Row	10 Row	12 Row
6 (236)	0.50 (0.12)	0.62 (0.15)	0.76 (0.19)	0.90 (0.22)	0.62 (0.15)	0.72 (0.18)	0.89 (0.22)	1.05 (0.26)	0.74 (0.18)	0.86 (0.21)	1.02 (0.25)	1.23 (0.31)
8 (315)	0.62 (0.15)	0.76 (0.19)	0.90 (0.22)	1.03 (0.26)	0.72 (0.18)	0.89 (0.22)	1.05 (0.26)	1.22 (0.30)	0.84 (0.21)	1.04 (0.26)	1.22 (0.30)	1.41 (0.35)
10 (394)	0.76 (0.19)	0.94 (0.23)	1.10 (0.27)	1.28 (0.32)	0.89 (0.22)	1.09 (0.27)	1.30 (0.32)	1.53 (0.38)	1.04 (0.26)	1.28 (0.32)	1.51 (0.38)	1.77 (0.44)
12 (472)	0.89 (0.22)	1.10 (0.27)	1.34 (0.33)	1.55 (0.39)	1.06 (0.26)	1.31 (0.33)	1.58 (0.39)	1.81 (0.45)	1.21 (0.30)	1.51 (0.38)	1.80 (0.45)	2.17 (0.54)

Based on 80/67°F (27/19°C) EAT, 55/54°F (13/12°C) LAT, 42°F (6°C) EWT - 12°F (7°C) ΔT

\* fins per meter

Coil Air pressure Drop in w.g. (KPa)

### 5/8" (15.88 mm) Heating Coil

FPI (fpm*)	Face Velocity - FPM (m/s)							
	500 (2.54)		600 (3.05)		700 (3.56)		800 (4.06)	
	1 Row	2 Row	1 Row	2 Row	1 Row	2 Row	1 Row	2 Row
6 (236)	0.06 (0.01)	0.12 (0.03)	0.08 (0.02)	0.16 (0.04)	0.11 (0.03)	0.22 (0.05)	0.14 (0.03)	0.28 (0.07)
8 (315)	0.08 (0.02)	0.16 (0.04)	0.11 (0.03)	0.22 (0.05)	0.14 (0.03)	0.27 (0.07)	0.18 (0.04)	0.33 (0.08)
10 (394)	0.10 (0.02)	0.20 (0.05)	0.14 (0.03)	0.28 (0.07)	0.18 (0.04)	0.35 (0.09)	0.22 (0.05)	0.40 (0.10)
12 (472)	0.12 (0.03)	0.25 (0.06)	0.17 (0.04)	0.33 (0.08)	0.22 (0.05)	0.40 (0.10)	0.27 (0.07)	0.50 (0.12)

Based on 55°F (13°C) EAT, 80°F (27°C) LAT, 180°F (82°C) EWT - 20°F (11°C) ΔT

\* fins per meter

Coil Air pressure Drop in w.g. (KPa)

### Standard Vee-Blade Damper Pressure Drop, in w.g. (KPa)

Damper Size inch (mm)	Velocity, FPM (m/s)		
	1000 (5.08)	1500 (7.62)	2000 (10.16)
24 (609.6) x 24 (609.6)	0.11 (0.03)	0.24 (0.06)	0.47 (0.12)
36 (914.4) x 36 (914.4)	0.08 (0.02)	0.22 (0.05)	0.38 (0.09)

Values based on unducted damper mounting.

### Aluminum Airfoil Blade Damper Pressure Drop, in w.g. (KPa)

Damper Size inch (mm)	Velocity, FPM (m/s)		
	1000 (5.08)	1500 (7.62)	2000 (10.16)
24 (609.6) x 24 (609.6)	0.13 (0.03)	0.19 (0.05)	0.31 (0.08)
36 (914.4) x 36 (914.4)	0.06 (0.02)	0.16 (0.04)	0.21 (0.05)

Values based on unducted damper mounting.

### Rain Hood with Bird Screen

Outlet Velocity - FPM (m/s)	500 (2.54)	750 (3.81)	1000 (5.08)	1250 (6.35)	1500 (7.62)
A.P.D. - in w.g. (KPa)	0.05 (0.01)	0.09 (0.02)	0.12 (0.03)	0.15 (0.04)	0.20 (0.05)

Dual Drainable Louvers	Based on 48" x 48" Louver Size									
Gross Face Velocity - FPM (m/s)	200 (1.02)	300 (1.52)	400 (2.03)	500 (2.54)	600 (3.05)	700 (3.56)	800 (4.06)	900 (4.57)	1000 (5.08)	
A.P.D. - in w.g. (KPa)	0.02 (0.005)	0.05 (0.01)	0.09 (0.02)	0.13 (0.03)	0.16 (0.04)	0.24 (0.06)	0.30 (0.07)	0.40 (0.10)	0.50 (0.12)	

## Guide Specifications: Indoor Air Handling Unit

### Part 1 — General

#### 1.01 QUALITY ASSURANCE

A. Manufacturer Qualifications: Company specializing in manufacturing the products specified in this section with minimum of 10 years documented experience.

B. Air-handling unit assembly shall have UL 1995 certification for safety, including use with electric heat.

C. Products requiring electric connection shall be listed and classified by ETL and CSA as suitable for the purpose specified and indicated.

D. Coil performance shall be certified in accordance with AHRI Standard 410.

E. Air-handling unit shall be AHRI 430 listed and meet NFPA 90A requirements.

#### 1.02 DELIVERY, STORAGE AND PROTECTION

A. All indoor units, painted or unpainted, shall be completely shrink-wrapped from the factory for protection during shipment. Tarping of bare units is unacceptable.

B. Inspect for transportation damage and store in clean dry place and protect from weather and construction traffic. Handle carefully to avoid damage to components, enclosures and finish.

#### 1.03 START-UP REQUIREMENTS

Do not operate units until ductwork is clean, filters are in place, bearings lubricated, condensate properly trapped, piping connections verified and leak tested, belts aligned and tensioned, all shipping braces have been removed and fan has been test run under observation. More detailed information can be found under the GENERAL START UP GUIDELINE found in this section.

### Part 2 — Products

#### 2.01 GENERAL DESCRIPTION

A. Units shall ship in the number of sections necessary to meet project requirements and shall ship in as many splits as specified in selection software. Split options as follows:

1. Shipped in sections — shipping split.
2. Shipped assembled.

B. Unit shall be factory-supplied, central station air handler. The air-handling unit may consist of a fan with the following factory-installed components as indicated on the equipment schedule.

1. Mixing Box Section:
  - a. With filter tracks.
  - b. No filter tracks.
2. Air Mixer Section.
3. Exhaust Box Section.
4. Internal Face and Bypass Section:
  - a. With hot water coil.
  - b. With steam coil.
5. Internal Face and Bypass Damper Section.
6. External Face and Bypass Damper Section.
7. Plenum Section:
  - a. With drain pan.
  - b. No drain pan.
8. Humidifier Section.
9. Blow-Thru Discharge Plenum.
10. Filter Section:
  - a. 2 in. (51 mm) flat filters.
  - b. 4 in. (102 mm) flat filters.

c. 2 in. (51 mm) angle filters.

d. 4 in. (102 mm) angle filters.

e. Side loading 12 in. (305 mm) cartridge filters with 2 in. (51 mm) pre-filters.

f. Side loading 21 in. (533 mm) bag filters with 2 in. (51 mm) pre-filters.

g. Face loading bag/cartridge filters without pre-filters. Maximum bag/cartridge filter length is limited to access/plenum sections placed after this section.

h. Face loading HEPA (High-Efficiency Particulate Air) cartridge filters without pre-filters.

#### 11. Coil Section:

- a. Chilled water coil.
- b. Direct expansion coil.
- c. Hot water coil.
- d. Steam coil.
- e. Electric coil.

#### 12. Multi-Zone Cooling/Heating Coil Section:

- a. With dampers.
- b. No dampers (for dual duct).

#### 13. Fan Section:

- a. Horizontal draw-thru.
- b. Horizontal blow-thru (with integral diffuser).

#### 2.02 CASING

##### A. Construction:

1. Unit shall be constructed of a complete frame with easily removable panels. Removal of any panel shall not affect the structural integrity of the unit.
2. All units shall be supplied with 14 gauge (1.98 mm) or heavier, G-90 galvanized steel base rails, formed rectangular tube or structural 'C' channel. Perimeter lifting lugs for overhead lifting shall be provided on each section. Slings in place of lifting lugs shall not be acceptable.
3. Unit shall be thermally broken to minimize the conduction path from the inside of the casing to the outside.
4. Casing panels (top, sides and bottom) shall be constructed of galvanized steel and shall have one of the following exterior finishes as specified:
  - a. Pre-painted with a baked enamel finish passing 500-hour salt spray test (ASTM B-117) for pre-painted steel and 125-hour marine level 1 Prohesion test (ASTM G-85.A5) for pre-painted steel.
  - b. Unpainted G-90 galvanized steel.
5. Casing panels (top, sides and bottom) shall be constructed of galvanized steel and shall have one of the following interior finishes as specified:
  - a. Pre-coated with a silver zeolite antimicrobial material registered by the US EPA for use in HVAC applications.
  - b. Unpainted G-90 galvanized steel.
6. Casing panels (top, sides and bottom) shall be one piece, double-wall construction with insulation sealed between the inner and outer panels. Panel assemblies shall not carry an R value of less than 13.
7. Casing deflection shall not exceed a 1:200 ratio when subject to an internal pressure of  $\pm 8$  in. w.g. ( $\pm 1.99$  KPa) Casing leakage rate shall be less than 1% at 8 in. w.g. (1.99 KPa) of nominal unit airflow or 50 CFM (85 m<sup>3</sup>/hr.), whichever is greater. Leakage rate shall be tested and documented on a routine basis on random production units.



## Guide Specifications: Indoor Air Handling Unit

8. Side panels shall be easily removable for access to unit and shall seal against a full perimeter automotive style gasket to ensure a tight seal.
9. The panel retention system shall comply with UL 1995 which states all moving parts (for example, fan blades, blower wheels, pulleys and belts) that, if accidentally contacted, could cause bodily injury, shall be guarded against accidental contact by an enclosure requiring tools for removal.
10. Accessibility options shall be as follows:
  - a. Hinged double-wall access door on either side with removable access panel(s) on the other side.
  - b. Hinged double-wall access doors on both sides.
  - c. Removable double-wall access panels on both sides.
11. Depending on the options selected and the remaining available space inside each section, the following options may be available:
  - a. Thermal pane reinforced glass viewports shall be factory-installed on the access panel(s) or door(s) of the section.
  - b. Marine lights shall be factory installed with or without GFCI (ground fault circuit interrupter) convenience outlets.
12. Fan supports, structural members, panels, or flooring shall not be welded, unless aluminum, stainless steel, or other corrosion-resistant material is used. Painted welds on unit exterior steel or galvanized steel are not acceptable.
13. All coil sections shall be double wall construction with insulation sealed between the inner and outer panels. Panel assemblies shall not carry an R value of less than 13. Single height coil sections shall have removable frame sections to facilitate vertical coil extraction.
14. Blow-thru sections shall have a diffuser plate as an integral part of the fan section.

**B. Access Doors:** Access doors shall be one piece, double-wall construction with insulation sealed between the inner and outer panels. Panel assemblies shall not carry an R value of less than 13.

**C. Drain Pans:** Drain pans shall be insulated double-wall galvanized or stainless steel construction. The pan shall be sloped toward the drain connection. Drain pan shall have 1.5 in. (38 mm) MPT connection exiting through the hand side or opposite side of the casing as specified. One drain outlet shall be supplied for each cooling coil section. Drain pan shall allow no standing water and comply with ASHRAE Standard 62. Where 2 or more coils are stacked in a coil bank, intermediate drain pans shall be provided and the condensate shall be piped to the bottom drain pan. The bottom coil shall not serve as a drain path for the upper coil.

### 2.03 FANS

#### A. General:

1. Forward-curved fans shall have one double width double-inlet (DWDI) fan wheel and scroll. They shall be constructed of galvanized steel with baked enamel. They shall be designed for continuous operation at the maximum rated fan speed and motor horsepower. Fans shall have an AMCA class rating corresponding to the static pressure at which the fan is designed to operate (Class I or II). Completed fan assembly shall be dynamically balanced in accordance with 1989 ARI Guideline G and ANSI S2.19- 1986 at design operating speed using contract drive and motor if ordered.
2. Airfoil fan sections shall have one DWDI airfoil fan wheel and scroll. Airfoil blades shall be double thickness design constructed of heavy gauge, high strength steel or aluminum continuously welded to the back plate and the spun inlet flange.

Entire fan assembly shall be cleaned, primed and painted with alkyd enamel, except for an aluminum fan wheel when supplied. Fans shall have an AMCA class rating corresponding to the static pressure at which the fan is designed to operate (Class I, II or III). Completed fan assembly shall be dynamically balanced to minimum grade of G 6.3 per ANSI/AMCA 204-96 at design operating speed using contract drive and motor if ordered.

3. Plenum fan sections shall have one single-width single-inlet (SWSI) airfoil fan wheel. Airfoil blades shall be double thickness design constructed of heavy gauge, high strength steel or aluminum continuously welded to the back plate and the spun inlet flange. Entire fan assembly shall be cleaned, primed and painted with alkyd enamel, except for an aluminum fan wheel when supplied. They shall be designed for continuous operation at the maximum rated fan speed and motor horsepower. Fans shall have an AMCA class rating corresponding to the static pressure at which the fan is designed to operate (Class I, II or III). Completed fan assembly shall be dynamically balanced to minimum grade of G 6.3 per ANSI/AMCA 204-96 at design operating speed using contract drive and motor if ordered.
4. Fan wheels shall be keyed to the shaft and shall be designed for continuous operation at maximum rated fan speed and motor horsepower. Fan wheels and shafts shall be selected with a maximum operating speed 25% below the first critical.
5. Fan motor shall be mounted within the fan section casing on slide rails equipped with adjusting screws. Motor shall be premium efficiency, open drip-proof or totally enclosed fan cooled NEMA Design B with size and electrical characteristics as shown on the equipment schedule. Motor shall be mounted on a horizontal flat surface and shall not be supported by the fan or its structural members.

All three-phase motors shall have a  $\pm$  10% voltage utilization range and a 1.15 minimum service factor. Motor shall be compliant with the Energy Independence and Security Act (EISA) of 2007 where applicable. Single-phase motors shall be available up to and including 5 HP (3.7 Kw).

#### B. Performance Ratings:

Fan performance shall be rated and certified in accordance with AHRI Standard 430.

**C. Sound Ratings:** Manufacturer shall submit first through eighth octave sound power for fan discharge and casing radiated sound.

**D. Mounting:** Fan scroll, wheel, shaft, bearings, drives and motor shall be mounted on a common base assembly. The base assembly is isolated from the outer casing with factory-installed isolators and rubber vibration absorbent fan discharge seal. A canvas style duct connection between fan discharge and cabinet is not acceptable. Units shall use 2 in. (51 mm) deflection spring isolators.

#### E. Fan Accessories:

1. Forward-curved fans:
  - a. Variable frequency drives with or without bypass.
  - b. Magnetic motor starters.
  - c. Motor disconnects.
  - d. Belt guards.
  - e. Inlet screen.
2. Airfoil Fans:
  - a. Variable frequency drives with or without bypass.
  - b. Magnetic motor starters.
  - c. Motor disconnects.
  - d. Belt guards.
  - e. Inlet screen.

# Guide Specifications: Indoor Air Handling Unit

3. Plenum Fans:
  - a. Variable frequency drives with or without bypass.
  - b. Magnetic motor starters.
  - c. Motor disconnects.
  - d. Inlet screen and wheel cage.

## F. Flexible Connection:

The base assembly is isolated from the outer casing with factory-installed isolators and rubber vibration absorbent fan discharge seal. A canvas style duct connection between fan discharge and cabinet is not acceptable.

## 2.04 BEARINGS AND DRIVES

### A. Bearings:

Self-aligning, grease lubricated, anti-friction with lubrication fittings extended to drive side of fan section. Optional grease fittings extended to the exterior of the casing are available.

Heavy-duty pillow block type, self-aligning, re-greasable ball or roller type bearings selected for a minimum average life (L50) of 200,000 hours or optionally for an (L50) of 500,000 hours.

### B. Shafts:

Fan shafts shall be solid steel, turned, ground, polished and coated with a rust inhibitor.

### C. V-Belt Drive:

Drive shall be designed for a minimum 1.2 service factor as standard with a 1.5 service factor option and/or a factory-supplied extra set of belts. Drives shall be fixed pitch with optional variable pitch for motors 15 HP (11.2 Kw) and less. All drives shall be factory mounted, with sheaves aligned and belts properly tensioned.

## 2.05 COILS

A. All water, steam and direct expansion (DX) refrigerant coils shall be provided to meet the scheduled performance. All coil performance shall be certified in accordance with AHRI Standard 410. All water and direct expansion coils shall be tested at 450 psig (32 bars) air pressure. Direct expansion coils shall be designed and tested in accordance with ASHRAE/ANSI 15 Safety Code for Mechanical Refrigeration.

### B. General Fabrication:

1. All water and refrigerant coils shall have minimum 1/2 in. (13 mm) OD copper tubes mechanically expanded into fins to ensure high thermal performance with lower total flow and pumping requirements. Minimum tube wall thickness shall be 0.016 in. (0.4 mm). Optional tube wall thickness of 0.025 in. (0.6 mm) shall be supplied, if specified.
2. Optionally, water coils shall have minimum 5/8 in. (16 mm) OD copper tubes mechanically expanded into fins to ensure high thermal performance with lower total flow and pumping requirements. Minimum tube wall thickness shall be 0.020 in. (0.5 mm). Optional tube wall thickness of 0.035 in. (0.9 mm) shall be supplied, if specified.
3. Aluminum plate fin type with belled collars. Optional copper plate fins shall be supplied, if specified.
4. Aluminum-finned coils shall be supplied with die-formed casing and tube sheets of mill galvanized steel or stainless steel as specified. Copper-finned coils shall be supplied with stainless steel casing and tube sheets.

### C. Hydronic Heating and Cooling Coils:

1. Headers shall be constructed of steel with steel MPT connections. Headers shall have drain and vent connections accessible from the exterior of the unit. Optional non-ferrous headers and red brass nipples shall be supplied if specified.

2. Configuration: Coils shall be drainable, with non-trapping circuits. Coils will be suitable for a design working pressure of 300 psig (22 bars) at 200°F (93°C).

### D. Steam Distribution (Non-Freeze Type) Heating Coils:

1. Headers shall be steel with MPT connections.
2. Inner steam distributing tubes shall be 5/8 in. (16 mm) OD with 0.020 in. (0.5 mm) wall thickness and located within 1 in. (25 mm) OD, 0.030 in. (0.8 mm) wall outer condensing tubes. Working pressure shall be 175 psig (13 bars) at 400°F (204°C).
3. Inner steam distributing tubes shall be 3/8 in. (10 mm) OD, 0.020 in. (0.5 mm) wall thickness and located within 5/8 in. (16 mm) OD 0.035 in. (0.9 mm) wall outer condensing tubes. Working pressure shall be 175 psig (13 bars) at 400°F (204°C).

### E. Integral Face and Bypass Coils:

Coils shall have vertical steam or hot water coils with a tube wall thickness of not less than 0.035 in. (0.9 mm).

Aluminum plate fin type with belled collars. Optional copper plate fins shall be supplied, if specified.

### F. Refrigerant Coils:

1. Headers shall be constructed of copper with brazed joints.
2. Standard circuiting selections include:
  - a. Single distributor arrangement.
  - b. Row split inter-twined, multiple distributor arrangement.
  - c. Face-split multiple distributor arrangement.
3. Replaceable nozzle, brass refrigerant distributors and seamless copper distribution tubes are supplied to ensure uniform flow.

### G. Electric Heating Section:

1. The electric heater casing is constructed of galvanized steel. Heater control box access door shall be mounted on the designated hand side of the unit. Element construction as follows:
  - a. Open-wire type, 80% nickel, 20% chromium resistance coils, insulated by Steatite bushings and supported in a galvanized steel frame. Bushings shall be recessed into embossed openings and stacked into supporting brackets. Thermal cutouts for over temperature protection shall be provided to meet UL and NEC requirements.
2. The manufacturer shall furnish an integral control box containing thermal cutouts, primary control, sub-circuit fusing, airflow switch and fused control transformer.
3. Electric heaters shall be UL listed for zero clearance and shall meet all applicable National Electric Code requirements.
4. Units with electric heat sections shall be listed under UL 1995 Standard for Safety.

## 2.06 HUMIDIFIERS

A. The humidifiers shall be of the direct discharge type, using steam from existing steam lines or boilers to be injected into the air plenums for humidification.

B. Each humidifier shall consist of multiple, vertical steam discharge pipes, supported on horizontal header manifolds, spaced to provide the optimum of steam to air contact while minimizing pressure drop.

Each humidifier shall be sized to nominally match the air plenum width and height for maximum contact of the discharging steam to the air passing around the vertical steam discharge pipes.

C. The vertical steam discharge pipes shall be constructed of 316 stainless steel material. Each pipe shall have a full-length, inverted slot on each side for steam discharge at 100% air to steam contact. Nozzles and holes have less than 15% air to steam contact and are, therefore, unacceptable.

## Guide Specifications: Indoor Air Handling Unit

D. A full-length stainless steel fishbone shaped baffle shall be used inside the vertical discharge pipe to wick condensate away from the discharge slots and back to the center of the pipe for re-evaporation.

E. The feeder manifolds shall be constructed of 316 stainless steel material, it sized to move the steam in a specific mass-flow speed range, for maximum condensate separation. Final condensate separation shall occur inside the feeder manifolds, after the control valve, with the dried steam then injected directly into the vertical discharge pipes.

F. The vertical steam discharge pipes and horizontal feeder manifolds shall be coated with a thin, nontoxic insulated coating capable of reducing surface temperature to no more than 120°F (49°C) during operation to reduce heat gain to the airstream. The insulated coating shall have an insulating value at 0.03 in. (0.8 mm) equal to 8 in. (203 mm) of R 40 foam. The insulated coating shall have a flame spread and smoke developed rating of 5 under ASTM E-84 with a crosshatch adhesion of 100% under ASTM D-3359, acceptable for use in air ducts.

G. The steam humidifier shall be designed with slip fittings for easy assembly. The steam humidifier shall be designed without plastic nozzles, collars, O-rings or gaskets for zero maintenance.

### 2.07 FILTER SECTIONS

A. Flat filter sections shall accept either 2 in. (51 mm) or 4 in. (102 mm) filters.

Sections shall include side access slide rails.

B. Angle filter sections shall accept either 2 in. (51 mm) or 4 in. (102 mm) filters of standard sizes, arranged in a horizontal V formation.

C. Draw-thru bag/cartridge filter sections shall be capable of accepting standard size 6 in. (152 mm) to 12 in. (305 mm) deep rigid media or bag filters.

D. Draw-thru bag/cartridge filter sections shall be capable of accepting standard size 12 in. (305 mm) to 21 in. (533 mm) deep rigid media or bag filters.

E. Blow-thru bag/cartridge filter sections shall contain a face loading filter frame and be capable of accepting standard size 12 in. (305 mm) deep rigid media or bag filters.

F. Blow-thru HEPA filter sections shall contain a face loading filter frame and be capable of accepting standard size 12 in. (305 mm) deep HEPA filters.

G. Gages:

1. Housing shall be constructed of die cast aluminum case and bezel with acrylic cover. Exterior finish shall be coated gray paint.
2. Accuracy shall be  $\pm 2\%$  of full scale throughout range at 70°F (21°C).
3. Diameter of dial face shall be 4 in. (102 mm).
4. Process connections shall be 1/8 in. (3 mm) female NPT duplicate high and low pressure taps one pair side and one pair back.

### 2.08 DAMPERS

A. Mixing boxes, filter-mixing boxes and exhaust boxes shall have parallel or opposed blades and interconnecting outside-air and return-air dampers.

1. Standard Dampers:

Damper blades shall be constructed of galvanized steel; with bulb type extruded blade seals, cambered steel jamb seals and 1/2 in. (13 mm) Celcon® type bearings. Blades shall be mechanically fastened to axle rods rotating in self-lubricating synthetic bearings.

2. Premium Dampers:

Damper blades shall be constructed of extruded aluminum airfoil design, with mechanically locked in place Silicone type blade seals, cambered stainless steel jamb seals and 1/2 in. (13 mm) Oillite® self-lubricating bronze bearings. Blades shall be mechanically fastened to axle rods rotating in self-lubricating synthetic bearings.

- a. Linkage shall be galvanized steel, concealed in frame.
- b. Axles shall be minimum 1/2 in. (13 mm) diameter plated steel, round-shaped, mechanically attached to blade.

- B. Integral Face and Bypass Dampers:

1. Integral face and bypass (IFB) coils shall be capable of maintaining a constant air volume, shall be capable of maintaining a constant leaving air temperature as entering air conditions vary and shall be capable of producing mixed leaving air temperatures downstream with a maximum variance in air temperature regardless of damper position.
2. When no heating is required, dampers shall divert air to bypass around heating surface with minimal temperature override.
3. Coil casing, dampers and baffles shall be fabricated from galvanized steel with an option for stainless steel. Coils shall be tested at 300 psig (22 bars).
4. Integral face and bypass coils shall be provided with a connection point for field-mounted actuator(s), electrical or pneumatic, or can be provided from the factory at an additional cost.
5. Actuator connection point shall be mechanically attached to dampers via linkage mechanisms. Dampers shall be interconnected for operation simultaneously across each face of coil.

- C. Face and Bypass Dampers:

1. Internal Face and Bypass Dampers:

Internal face and bypass dampers shall be factory mounted in galvanized steel frame. Damper blades shall be constructed of galvanized steel, with high temperature blade and edge seals. Blades shall be mechanically fastened to axle rods rotating in synthetic bearings. Face damper blades shall be opposed and arranged to match coil face with top bypass and internal linkage.

2. External Face and Bypass Dampers:

Face damper shall be factory mounted in galvanized steel frame. Damper blades shall be constructed of galvanized steel, with high temperature blade and edge seals. Blades shall be mechanically fastened to axle rods rotating in synthetic bearings. Bypass damper shall be constructed of galvanized steel, with blade seals and cambered steel jamb seals. Blades shall be mechanically fastened to axle rod rotating in synthetic bearings. Face damper blades shall be opposed with top bypass and internally mounted linkage.

- D. Multi-Zone Dampers:

Multi-zone dampers shall be factory mounted in galvanized steel frame. Damper blades shall be constructed of galvanized steel with blade seals and cambered steel jamb seals. Blades shall be mechanically fastened to axle rods rotating in synthetic bearings.

### 2.09 AIR BLENDER

The air blender shall mix two or more airstreams of differing temperature to a mixed-air temperature and provide a more uniform air velocity contour entering a downstream filter or coil bank.



## Guide Specifications: Indoor Air Handling Unit

### 2.10 UV-C GERMICIDAL LAMPS

Emitters and fixtures for UV lamps shall be designed for use inside an HVAC system.

A. Power supplies for UV lamps shall be a high-efficiency electronic type which are matched to the emitters and are capable of producing the specified output intensity with an input power no more than 80 watts.

B. Fixtures for UV lamps shall be factory installed and wired to a SPDT disconnect switch and door interlock switches in each door. Fixtures are wired for 120V/1Ø requiring a minimum circuit ampacity of 15 amps. Lamps shall ship separately for field installation to minimize the chance for bulb damage.

C. Emitters and fixtures shall be installed in sufficient quantity and arranged so as to provide an equal distribution of UV light on the coil and drain pan.

D. UV lights striking the strike the drain either directly or indirectly through reflection.

E. Emitters and fixtures shall be installed such that UV energy strikes all surfaces of the coil, drain pan and the available line of sight airstream.

### 2.11 ELECTRICAL ACCESSORIES:

A. Marine Lights and Convenience Outlets:

1. Cast, non-ferrous metal, weatherproof, fixture.
2. Cast, non-ferrous metal, weatherproof, electrical junction box.
3. Sealed, heat and shock resistant glass globe protects against moisture and debris.
4. Cast, non-ferrous metal lamp guard to protect glass globe.
5. UL listed.
6. 100 watt type 'A' lamp maximum capacity.
7. Each fixture is equipped with a 75 watt, 120 volt, long life, vibration resistant, lamp factory installed.
8. Metallic, single gang, electrical junction box, UL listed.
9. Convenience outlet: Factory supplied and wired, SPST, toggle switch and 15 Amp, 120 VAC/60 Hz, NEMA 5-15 type, ground fault circuit interrupt (GFCI) receptacle, UL listed.
10. No convenience outlet: Factory supplied and wired, SPST, UL listed toggle switch.
11. Each fixture is factory wired to an externally mounted switch box. (Field power connections are made to the switch box mounted externally on the unit.)
12. All factory wirings penetrating through the panel is protected in 'RIGID' type metal conduit.

B. Disconnects:

1. 115-230V/1Ø non-fused disconnects shall have the following characteristics:
  - a. Plated current carrying components for superior corrosion protection.
  - b. Factory-installed equipment grounding terminals with slot/square drive screws.
  - c. Rated for motor disconnects applications (10 HP / 7.5 Kw maximum).

d. NEMA type 3R non-metallic enclosure.

e. Up to 10,000 RMS symmetrical amperes SCCR, when protected by a fuse or circuit breaker rated 60 amperes or less.

f. Cover padlock hasp.

g. Pull-out cartridge type.

h. UL listed.

2. 115-230V/1Ø fused disconnects shall have the following characteristics:

a. Visible blades.

b. Quick-make, quick-break operating mechanism.

c. Cover padlock hasp and handle lock "OFF".

d. 240 VAC maximum.

e. Factory supplied and installed class 'T Series' fuses (fused disconnects only).

f. Up to 10,000 RMS symmetrical amperes SCCR, utilizing appropriately rated factory supplied fuses.

g. Horsepower rated for motor applications.

h. Tangential combination knockouts for field wiring.

i. Spring reinforced plated copper fuse clips.

j. NEMA 1 type enclosures.

k. Insulated, bondable solid neutral assemblies.

l. UL listed, File E2875.

m. Meet or exceed NEMA KS1 standard.

3. 200-230V/3Ø fused and non-fused disconnects shall have the following characteristics:

a. Visible blades.

b. Quick-make, quick-break operating mechanism.

c. Cover padlock hasp and handle lock "OFF".

d. 240 VAC maximum.

e. Factory supplied and installed class RK5 fuses (fused disconnects only).

f. Up to 100,000 RMS symmetrical amperes SCCR, utilizing appropriately rated, factory supplied Class R fuses.

g. Horsepower rated for motor applications.

h. Tangential combination knockouts for field wiring.

i. Spring reinforced plated copper fuse clips.

j. NEMA 1 type enclosures.

k. Insulated, bondable solid neutral assemblies.

l. UL listed, File E2875.

m. Meet or exceed NEMA KS1 standard.

4. 380-575V/3Ø fused and non-fused disconnects shall have the following characteristics:

a. Visible switch blades with for positive "OFF" indication.

b. Quick-make, quick-break operating mechanism.

c. Dual cover interlock.

d. Color coded "ON" / "OFF" indicator handle.

e. Cover padlock hasp and handle lock "OFF" provision for multiple padlocks.

f. 600 VAC maximum.

g. Factory supplied and installed class RK5 fuses (fused disconnects only).

## Guide Specifications: Indoor Air Handling Unit

- h. Up to 200,000 RMS symmetrical amperes SCCR, utilizing appropriately rated, factory supplied Class R fuses.
  - i. Horsepower rated for motor applications.
  - j. Spring reinforced plated copper fuse clips.
  - k. Tangential combination knockouts.
  - l. NEMA 1 type enclosures.
  - m. Insulated, bondable solid neutral assemblies.
  - n. Wire terminations suitable for aluminum or copper conductors.
  - o. UL listed.
  - p. Meet or exceed NEMA KS1 standard.
- C. Starters:
1. Starter without disconnect:
    - a. Adjustable motor overload with trip indication.
    - b. Manual overload reset button (accessible without opening enclosure).
    - c. 115V fused secondary control transformer (fuse included - fused primary and secondary over 50 amps).
    - d. Hand/Off/Auto selector switch (accessible without opening enclosure).
    - e. Separate 4-position terminal strip for remote H-O-A wiring.
    - f. C series contactors.
    - g. Horsepower rated for motor applications.
    - h. NEMA 4X type non-metallic enclosures.
    - i. Lug connections for field wiring.
    - j. Factory mounted, wired and run tested with factory-supplied motor.
    - k. UL listed.
  2. Combination Starter/Disconnect:
    - a. Non-fused UL 508 Disconnect Switch with Lockable Handle (locks not provided).
    - b. Cover interlock.
    - c. Adjustable motor overload with trip indication.
    - d. Manual overload reset button (accessible without opening enclosure).
    - e. 115V fused secondary control transformer (fuse included - fused primary and secondary over 50 amps).
    - f. Hand/Off/Auto selector switch (accessible without opening enclosure).
    - g. Separate 4-position terminal strip for remote H-O-A wiring.
    - h. C series contactors.
    - i. Horsepower rated for motor applications.
    - j. NEMA 4X type non-metallic enclosures.
    - k. Lug connections for field power wiring.
    - l. Factory mounted, wired and run tested with factory-supplied motor.
    - m. UL listed.
- D. Bypass for Variable Frequency Drives:
1. 200-230V/3Ø/60Hz, 460- 575V/3Ø/60Hz, 380V/3Ø/50Hz:
    - a. 4-position panel-mounted disconnect style switch with lockable handle (locks not provided), meets OSHA 1910.
    - b. Switch position indication (LINE/OFF/ DRIVE/TEST).
    - c. Adjustable motor overload with trip indication (LINE position).
    - d. Manual overload reset button.
    - e. Horsepower rated for motor applications.
    - f. Direct control (no contactors, relays or holding coils).
    - g. Complete isolation of inverter in LINE position.
    - h. NEMA 12 type metal enclosures.
    - i. Terminal strip provided for field power supply wiring.
    - j. Lug connection for field ground wire.
    - k. Gold flashed, auxiliary switch contact set (for switch position monitoring).
    - l. Factory mounted, wired to VFD and motor, and run tested (motor and VFD must be factory supplied and installed).
    - m. UL; UL, Canada; CE listed.
  2. 200-230V/3Ø/60Hz, 460-575V/3Ø/60Hz, 380V/3Ø/50Hz:
    - a. 4-position panel-mounted disconnect style switch with lockable handle (locks not provided), meets OSHA 1910.
    - b. Switch position indication (LINE/OFF/ DRIVE/TEST).
    - c. Adjustable motor overload with trip indication (in LINE position).
    - d. Manual overload reset button.
    - e. Horsepower rated for motor applications.
    - f. 115V control transformer with fused secondary (fused primary on units over 50 amps).
    - g. Contactor for Line Start/Stop.
    - h. Door-mounted Line Start and Line Stop pushbuttons.
    - i. Complete isolation of inverter in LINE position.
    - j. NEMA 12 type metal enclosures.
    - k. Terminal strip provided for field power supply wiring.
    - l. Lug connection for field ground wire.
    - m. Gold flashed, auxiliary switch contact set (for switch position monitoring).
    - n. Factory mounted, wired to VFD and motor and run tested (motor and VFD must be factory supplied and installed).
    - o. UL; UL, Canada; CE listed.
- E. Variable Frequency Drives:
1. Factory mounted Variable Frequency Drives (VFDs) shall be wired to factory-supplied motors.
  2. The VFD parameters are programmed into the controller and removable keypad. In the event that the VFD fails and needs replacement, the program can then be uploaded to the replacement VFD via the original keypad.
  3. The VFD package as specified herein shall be enclosed in a UL Listed type enclosure, exceeding NEMA enclosure design criteria (enclosures with only NEMA ratings are not acceptable), completely assembled and tested by the manufacturer in an ISO 9001 facility.



## Guide Specifications: Outdoor Air Handling Unit

### Part 1 — General

#### 1.01 QUALITY ASSURANCE

A. Manufacturer Qualifications: Company specializing in manufacturing the products specified in this section with minimum of 10 years documented experience.

B. Air-handling unit assembly shall have UL 1995 certification for safety, including use with electric heat.

C. Products requiring electric connection shall be listed and classified by ETL and CSA as suitable for the purpose specified and indicated.

D. Coil performance shall be certified in accordance with AHRI Standard 410.

E. Air-handling unit shall be AHRI 430 listed and meet NFPA 90A requirements.

#### 1.02 DELIVERY and STORAGE

Inspect equipment for transportation damage and store in clean dry place and protect from weather and construction traffic. Handle carefully to avoid damage to components, enclosures and finish.

#### 1.03 START-UP REQUIREMENTS

Do not operate units until ductwork is clean, filters are in place, bearings lubricated, condensate properly trapped, piping connections verified and leak tested, belts aligned and tensioned, all shipping braces have been removed and fan has been test run under observation.

### Part 2 — Products

#### 2.01 GENERAL DESCRIPTION

A. Units shall ship in the number of sections necessary to meet project requirements and shall ship in as many splits as specified in selection producer. Split options as follows:

1. Shipped in sections — shipping split.
2. Shipped assembled.

B. Unit shall be factory-supplied, factory-assembled, outdoor, curb-mounted air handler.

The air-handling unit may consist of a fan with the following factory-installed components as indicated on the equipment schedule.

1. Mixing Box Section:
  - a. With flat or angled filter tracks.
  - b. No filter tracks.
2. Air Mixer Section.
3. Exhaust Box Section.
4. Integral Face and Bypass Section:
  - a. With hot water coil.
  - b. With steam coil.
5. Internal Face and Bypass Damper Section.
6. Plenum Section:
  - a. With drain pan.
  - b. No drain pan.
7. Humidifier Section.
8. Blow-Thru Discharge Plenum.
9. Filter Section:
  - a. 2 in. (51 mm) flat filters.
  - b. 4 in. (102 mm) flat filters.
  - c. 2 in. (51 mm) angle filters.
  - d. 4 in. (102 mm) angle filters.
  - e. Side loading 12 in. (305 mm) cartridge filters with 2 in. (51 mm) pre-filters.
  - f. Side loading 21 in. (533 mm) bag filters with 2 in. (51 mm) pre-filters.
  - g. Face loading bag/cartridge filters without pre-filters. Maximum bag/cartridge filter length is limited to plenum section access opening, placed after this section.

h. Face loading HEPA (High-Efficiency Particulate Air) cartridge filters without pre-filters.

10. Coil Section:

- a. Chilled water coil.
- b. Direct expansion coil.
- c. Hot water coil.
- d. Steam coil.
- e. Electric coil.

11. Fan Section:

- a. Horizontal draw-thru.
- b. Horizontal blow-thru (with integral diffuser).
- c. Plenum fan.

#### 2.02 CASING

A. Construction:

1. Unit shall be constructed of a complete frame with easily removable panels. Removal of any panel shall not affect the structural integrity of the unit.
2. All units shall be supplied with a perimeter steel base rail. Perimeter lifting lugs for overhead lifting shall be provided. Slings units in place of lifting lugs shall not be acceptable.
  - a. 4 gauge (1.98 mm) or heavier, G-90 galvanized steel base rail with a pocket to accommodate roof curb.
  - b. Formed rectangular steel tube.
  - c. Structural steel 'C' channels.
3. Unit shall be thermally broken to minimize the conduction path from the inside of the casing to the outside.
4. Casing panels (top, sides and bottom) shall be constructed of galvanized steel and shall have one of the following exterior finishes as specified:
  - a. Pre-painted with a baked enamel finish passing 500-hour salt spray test (ASTM B-117) for pre-painted steel and 125-hour marine level 1 Prohesion test (ASTM G-85.A5) for pre-painted steel.
  - b. Unpainted G-90 galvanized steel.
5. Casing panels (top, sides and bottom) shall be constructed of galvanized steel and shall have one of the following interior finishes as specified:
  - a. Pre-coated with a silver zeolite antimicrobial material registered by the US EPA for use in HVAC applications.
  - b. Unpainted G-90 galvanized steel.
6. Roof shall be double-wall, pitched in two directions at a minimum roof slope of 1/4 in/ft. (21 mm/m) across the width of the unit. No penetrations shall be made in pressure sensitive panels. Roof shall incorporate a standing top seam. All seams in the roof shall be sealed and capped to prevent water infiltration into the unit.
7. Casing panels (top, sides and bottom) shall be one piece double-wall construction with insulation sealed between the inner and outer panels. Panel assemblies shall not carry an R value of less than 13.
8. Casing deflection shall not exceed a 1:200 ratio when subject to an internal pressure of  $\pm 8$  in. w.g. (1.99 KPa) Casing leakage rate shall be less than 1% at  $\pm 8$  in. w.g. (1.99 KPa) of nominal unit airflow or 50 CFM (85 m<sup>3</sup>/hr.), whichever is greater.
9. Side panels shall be easily removable for access to unit and shall seal against a full perimeter gasket to ensure a tight seal.
10. The panel retention system shall comply with UL 1995 which states all moving parts (for example, fan blades, blower wheels, pulleys and belts) that, if accidentally contacted, could cause bodily injury, shall be guarded against accidental contact by an enclosure requiring tools for removal.
11. Base rail shall overhang the curb to facilitate water run-off and

## Guide Specifications: Outdoor Air Handling Unit

protection of the curb to base connection from water intrusion.

12. Accessibility options shall be as follows:
  - a. Hinged double wall access door on either side with removable access panel(s) on the other side.
  - b. Hinged double wall access doors on both sides.
  - c. Removable double wall access panels on both sides.
13. Depending on the options selected and the remaining available space inside each section, the following options may be available:
  - a. Thermal pane reinforced glass viewports shall be factory-installed on the access panel(s) or door(s) of this section.
  - b. Marine lights shall be factory-installed with or without GFCI (ground fault circuit interrupter) convenience outlets.
14. Fan supports, structural members, panels, or flooring shall not be welded, unless aluminum, stainless steel, or other corrosion-resistant material is used. Painted welds on unit exterior steel or galvanized steel are not acceptable.
15. All coil sections shall be solid double-wall construction with insulation sealed between the inner and outer panels. Panel assemblies shall not carry an R value of less than 13.
16. Blow-thru fan sections shall have a diffuser plate as an integral part of the fan section.

**B. Access Doors:** Access doors shall be one piece double-wall construction with insulation sealed between the inner and outer panels. Panel assemblies shall not carry an R value of less than 13.

**C. Drain Pans:** Drain pans shall be insulated double-wall galvanized or stainless steel construction. The pan shall be sloped toward the drain connection. Drain pan shall have 1.5 in. (38 mm) MPT connection exiting through the hand side or opposite side of the casing as specified.

Drain connection shall be insulated from the drain pan to the point at which it exits the casing. One drain outlet shall be supplied for each cooling coil section. Drain pan shall allow no standing water and comply with ASHRAE Standard 62. Where 2 or more coils are stacked in a coil bank, intermediate drain pans shall be provided and the condensate shall be piped to the bottom drain pan. The bottom coil shall not serve as a drain path for the upper coil.

**D. Roof Curbs:**

1. Roof curb shall be delivered to jobsite in an unassembled, knockdown state.
2. Curb shall be constructed of 14 gauge (1.98 mm) G-90 galvanized steel, 12 to 24 inches (305 to 610 mm) in height.
3. Full perimeter wood nailers shall be securely mounted to curb sheet metal.
4. Curb channel supports will be supplied on all curbs exceeding 10 ft. (3.05 m) in total unit airway length.
5. Gasket between curb and unit shall be shipped for field installation with the unit curb.
6. Coil connection housing curb will be offered optionally to enclose coil piping. Multiple coil connection housings may be specified (up to two per side).

**E. Hoods and Louvers:**

1. Outside Air intake Hoods:
  - a. Outside air hoods shall be constructed of 18 gauge (1.3 mm) galvanized G-90 steel and sized for 100% of unit nominal CFM (shipped loose, field installation by others).
  - b. Hoods shall include easily accessible 1 in. (25 mm) moisture eliminators with a maximum velocity of no more than 500 FPM (2.54 m/s).
  - c. Expanded metal bird screen shall be provided to prevent entry

of unwanted materials into air handler.

2. Exhaust Air Hoods:

- a. Exhaust air hoods shall be constructed of 18 gauge (1.3 mm) galvanized G-90 steel and shipped loose for field installation by others.
- b. Expanded metal bird screen shall be provided to prevent entry of unwanted materials into air handler.

3. Side Intake Louvers:

- a. Frames and blades shall be 6063-T5 alloy, 0.080-in. (2.0 mm) thick, mechanically fastened with stainless steel fasteners. Frame depth shall be 4 inches (102 mm).
- b. Top Horizontal blades shall be designed to collect water and channels it out the concealed downspouts in the side frame.
- c. Louvers shall have 1/2 in., 19 gauge (13 mm, 1.0 mm) galvanized bird screen.
- d. Louver widths greater than 120 inches (3048 mm) shall be manufactured in section with hidden architectural style rear mullions.
- e. Louvers shall be designed to withstand a wind load of 20 lb./ft<sup>2</sup> (1.0 KPa).
- g. Water penetration shall be no more than 0.01 oz. /ft<sup>2</sup> (3.05 g/m<sup>2</sup>) of free area at 1250 FPM (6.4 m/s) per AMCA publication 511. The AMCA test was unable to determine the beginning water penetration for this louver due to the fact that it lies above 1250 FPM (6.4 m/s) through free area.
- h. Louver shall have a mill finish.

### 2.03 FANS

**A. General**

1. Forward-curved fans shall have one double width double-inlet (DWDI) fan wheel and scroll.
 

They shall be constructed of galvanized steel. They shall be designed for continuous operation at the maximum rated fan speed and motor horsepower. Fans shall have an AMCA class rating corresponding to the static pressure at which the fan is designed to operate (Class I or II). Completed fan assembly shall be dynamically balanced in accordance with 1989 AHRI Guideline G and ANSI S2.19- 1986 at design operating speed using contract drive and motor if ordered.
2. Airfoil fan sections shall have one DWDI airfoil fan wheel and scroll. Airfoil blades shall be double thickness design constructed of heavy gauge, high strength steel or aluminum continuously welded to the back plate and the spun inlet flange. Entire fan assembly shall be cleaned, primed and painted with alkyd enamel, except for an aluminum fan wheel when supplied. Fans shall have an AMCA class rating corresponding to the static pressure at which the fan is designed to operate (Class I, II or III). Completed fan assembly shall be dynamically balanced to minimum grade of G 6.3 per ANSI/ AMCA 204-96 at design operating speed using contract drive and motor if ordered.
3. Plenum fan sections shall have one single-width single-inlet (SWSI) airfoil fan wheel. Airfoil blades shall be double thickness design constructed of heavy gauge, high strength steel or aluminum continuously welded to the back plate and the spun inlet flange. Entire fan assembly shall be cleaned, primed and painted with alkyd enamel, except for an aluminum fan wheel when supplied. They shall be designed for continuous operation at the maximum rated fan speed and motor horsepower. Fans shall have an AMCA class rating corresponding to the static pressure at which the fan is designed to operate (Class I, II or III). Completed fan assembly shall be dynamically balanced to minimum grade of G 6.3 per ANSI/AMCA 204-96 at design operating speed using contract drive and motor if ordered.

## Guide Specifications: Outdoor Air Handling Unit

4. Fan wheels shall be keyed to the shaft and shall be designed for continuous operation at maximum rated fan speed and motor horsepower.
5. Fan motor shall be mounted within the fan section casing on slide rails equipped with adjusting screws. Motor shall be premium efficiency, open drip-proof or totally enclosed fan cooled NEMA Design B with size and electrical characteristics as shown on the equipment schedule.

Motor shall be mounted on a horizontal flat surface and shall not be supported by the fan or its structural members. All three-phase motors shall have a  $\pm 10\%$  voltage utilization range and a 1.15 minimum service factor. Motor shall be compliant with the Energy Independence and Security Act (EISA) of 2007 where applicable. Single-phase motors shall be available up to and including 5 HP (3.7 Kw).

**B. Performance Ratings:** Fan performance shall be rated and certified in accordance with AHRI Standard 430.

**C. Sound Ratings:** Manufacturer shall submit first through eighth octave sound power for fan discharge and casing radiated sound.

**D. Mounting:** Fan scroll, wheel, shaft, bearings, drives and motor shall be mounted on a common base assembly. The base assembly is isolated from the outer casing with factory-installed isolators and vibration absorbent a discharge seal. A canvas style duct connection between fan discharge and cabinet is not acceptable. Units shall use 2 in. (51 mm) deflection spring isolators.

**E. Fan Accessories:**

1. Forward curved fans:
  - a. Variable Frequency Drives (VFD) with or without bypass.
  - b. Magnetic motor starters.
  - c. Motor disconnects.
  - d. Belt guards.
  - e. Inlet screen.
2. Airfoil fans:
  - a. Variable Frequency Drives with or without bypass.
  - b. Magnetic motor starters.
  - c. Motor disconnects.
  - d. Belt guards.
  - e. Inlet screen.
3. Plenum fans:
  - a. Variable Frequency Drives with or without bypass.
  - b. Magnetic motor starters.
  - c. Motor disconnects.
  - d. Inlet screen and wheel cage.

**F. Flexible Connection:** The base assembly is isolated from the outer casing with factory-installed isolators and vibration absorbent fan discharge seal. A canvas style duct connection between fan discharge and cabinet is not acceptable.

### 2.04 BEARINGS AND DRIVES

**A. Bearings:**

Self-aligning, grease lubricated, anti-friction with lubrication fittings extended to drive side of fan section. Optional grease fittings extended to the exterior of the casing are available.

Heavy-duty pillow block type, self-aligning, re-greasable ball or roller type bearings selected for a minimum average life (L50) of 200,000 hours or optionally for an (L50) of 500,000 hours.

**B. Shafts:**

Fan shafts shall be solid steel, turned, ground, polished and coated with a rust inhibitor.

**C. V-Belt Drive:**

Drive shall be designed for a minimum 1.2 service factor as standard with a 1.5 service factor option and/or a factory-supplied extra set of belts. Drives shall be fixed pitch with optional variable pitch for motors 15 HP (11.2 Kw) and less. All drives shall be factory mounted, with sheaves aligned and belts properly tensioned.

### 2.05 COILS

**A.** All water, steam and direct expansion (DX) refrigerant coils shall be provided to meet the scheduled performance. All coil performance shall be certified in accordance with AHRI Standard 410. All water and direct expansion coils shall be tested at 450 psig (32 bars) air pressure. Direct expansion coils shall be designed and tested in accordance with ASHRAE/ANSI 15 Safety Code for Mechanical Refrigeration.

**B. General Fabrication:**

1. All water and refrigerant coils shall have minimum 1/2 in. (13 mm) OD copper tubes mechanically expanded into fins to ensure high thermal performance with lower total flow and pumping requirements. Minimum tube wall thickness shall be 0.016 in. (0.4 mm). Optional tube wall thickness of 0.025 in. (0.6 mm) shall be supplied, if specified.
2. Optionally, water coils shall have minimum 5/8 in. (16 mm) OD copper tubes mechanically expanded into fins to ensure high thermal performance with lower total flow and pumping requirements. Minimum tube wall thickness shall be 0.020 in. (0.5 mm). Optional tube wall thickness of 0.035 in. (0.9 mm) shall be supplied, if specified.
3. Aluminum plate fin type with belled collars. Optional copper plate fins shall be supplied, if specified.
4. Aluminum-finned coils shall be supplied with die-formed casing and tube sheets of mill galvanized steel or stainless steel as specified. Copper-finned coils shall be supplied with stainless steel casing and tube sheets.

**C. Hydronic Heating and Cooling Coils:**

1. Headers shall be constructed of steel with steel MPT connections. Headers shall have drain and vent connections accessible from the exterior of the unit. Optional non-ferrous headers and red brass nipples shall be supplied if specified.
2. Configuration: Coils shall be drainable, with non-trapping circuits. Coils will be suitable for a design working pressure of 300 psig (22 bars) at 200°F (93°C).

**D. Steam Distribution (Non-Freeze Type) Heating Coils:**

1. Headers shall be steel with MPT connections.
2. Inner steam distributing tubes shall be 5/8 in. (16 mm) OD, 0.020 in. (0.5 mm) wall thickness and located within 1 in. (25 mm) OD 0.030 in. (0.8 mm) wall outer condensing tubes. Working pressure shall be 175 psig (13 bars) at 400°F (204°C).
3. Inner steam distributing tubes shall be 3/8 in. (10 mm) OD, 0.020 in. (0.5 mm) wall thickness and located within 5/8 in. (16 mm) OD 0.035 in. (0.9 mm) wall outer condensing tubes. Working pressure shall be 175 psig (13 bars) at 400°F (204°C).

**E. Integral Face and Bypass Coils:**

Coils shall have vertical steam or hot water coils with a tube wall thickness of not less than 0.035 in. (0.9 mm).

Aluminum plate fin type with belled collars. Optional copper plate fins shall be supplied, if specified.

**F. Refrigerant Coils:**

1. Headers shall be constructed of copper with brazed joints.
2. Standard circuiting selections include:
  - a. Single distributor arrangement.
  - b. Row split inter-twined, multiple distributor arrangement.



# Guide Specifications: Outdoor Air Handling Unit

c. Face-split multiple distributor arrangement.

3. Replaceable nozzle, brass refrigerant distributors and seamless copper distribution tubes are supplied to ensure uniform flow.

## G. Electric Heating Section:

1. The electric heater casing is constructed of galvanized steel. Heater control box access door shall be mounted on the designated hand side of the unit. Element construction as follows:
  - a. Open-wire type, 80% nickel, 20% chromium resistance coils, insulated by Steatite bushings and supported in a galvanized steel frame. Bushings shall be recessed into embossed openings and stacked into supporting brackets. Thermal cutouts for over temperature protection shall be provided to meet UL and NEC requirements.
2. The manufacturer shall furnish an integral control box containing thermal cutouts, primary control, sub-circuit fusing, airflow switch and fused control transformer.
3. Electric heaters shall be UL listed for zero clearance and shall meet all applicable National Electric Code requirements.
4. Units with electric heat sections shall be listed under UL 1995 Standard for Safety.

## 2.06 HUMIDIFIERS

A. The humidifiers shall be of the direct discharge type, using steam from existing steam lines or boilers to be injected into the air plenums for humidification.

B. Each humidifier shall consist of multiple, vertical steam discharge pipes, supported on horizontal header manifolds, spaced to provide the optimum of steam to air contact while minimizing pressure drop.

Each humidifier shall be sized to nominally match the air plenum width and height for maximum contact of the discharging steam to the air passing around the vertical steam discharge pipes.

C. The vertical steam discharge pipes shall be constructed of 316 stainless steel material. Each pipe shall have a full-length, inverted slot on each side for steam discharge at 100% air to steam contact. Nozzles and holes have less than 15% air to steam contact and are, therefore, unacceptable.

D. A full-length stainless steel fishbone shaped baffle shall be used inside the vertical discharge pipe to wick condensate away from the discharge slots and back to the center of the pipe for re-evaporation.

E. The feeder manifolds shall be constructed of 316 stainless steel material, it sized to move the steam in a specific mass-flow speed range, for maximum condensate separation. Final condensate separation shall occur inside the feeder manifolds, after the control valve, with the dried steam then injected directly into the vertical discharge pipes.

F. The vertical steam discharge pipes and horizontal feeder manifolds shall be coated with a thin, nontoxic insulated coating capable of reducing surface temperature to no more than 120°F (49°C) during operation to reduce heat gain to the airstream. The insulated coating shall have an insulating value at 0.03 in. (0.8 mm) equal to 8 in. (203 mm) of R 40 foam. The insulated coating shall have a flame spread and smoke developed rating of 5 under ASTM E-84 with a crosshatch adhesion of 100% under ASTM D-3359, acceptable for use in air ducts.

G. The steam humidifier shall be designed with slip fittings for easy assembly. The steam humidifier shall be designed without plastic nozzles, collars, O-rings or gaskets for zero maintenance.

## 2.07 FILTER SECTIONS

A. Flat filter sections shall accept either 2 in. (51 mm) or 4 in. (102 mm) filters.

Sections shall include side access slide rails.

B. Angle filter sections shall accept either 2 in. (51 mm) or 4 in. (102

mm) filters of standard sizes, arranged in a horizontal V formation.

C. Draw-thru cartridge filter sections shall be capable of accepting standard size 6 in. (152 mm) to 12 in. (305 mm) deep rigid media or bag filters.

D. Draw-thru bag/cartridge filter sections shall be capable of accepting standard size 12 in. (305 mm) to 21-in. (533 mm) deep rigid media or bag filters.

E. Blow-thru cartridge filter sections shall contain a face loading filter frame and be capable of accepting standard size 12 in. (305 mm) deep rigid media filters.

F. Blow-thru HEPA filter sections shall contain a face loading filter frame and be capable of accepting standard size 12 in. (305 mm) deep HEPA filters.

## G. Magnehelic Gages:

1. Housing shall be constructed of die cast aluminum case and bezel with acrylic cover. Exterior finish shall be coated gray paint.
2. Accuracy shall be  $\pm 2\%$  of full scale throughout range at 70°F (21°C).
3. Diameter of dial face shall be 4 in. (102 mm).
4. Process connections shall be 1/8 in. (3.0 mm) female NPT duplicate high and low pressure taps one pair side and one pair back.

## 2.08 DAMPERS

A. Mixing boxes, filter-mixing boxes and exhaust boxes shall have parallel or opposed blades and interconnecting outside-air and return-air dampers.

### 1. Standard Dampers:

Damper blades shall be constructed of galvanized steel; with bulb type extruded blade seals, cambered steel jamb seals and 1/2 in. (13 mm) Celcon® type bearings. Blades shall be mechanically fastened to axle rods rotating in self-lubricating synthetic bearings.

### 2. Premium Dampers:

Damper blades shall be constructed of extruded aluminum airfoil design, with mechanically locked in place Silicone type blade seals, cambered stainless steel jamb seals and 1/2 in. (13 mm) Oillite® self-lubricating bronze bearings. Blades shall be mechanically fastened to axle rods rotating in self-lubricating synthetic bearings.

a. Linkage shall be galvanized steel, concealed in frame.

b. Axles shall be minimum 1/2 in. (13 mm) diameter plated steel, round-shaped, mechanically attached to blade.

### B. Integral Face and Bypass Dampers:

1. Integral face and bypass (IFB) coils shall be capable of maintaining a constant air volume, shall be capable of maintaining a constant leaving air temperature as entering air conditions vary and shall be capable of producing mixed leaving air temperatures downstream with a maximum variance in air temperature regardless of damper position.
2. When no heating is required, dampers shall divert air to bypass around heating surface with minimal temperature override.
3. Coil casing, dampers and baffles shall be fabricated from galvanized steel with an option for stainless steel. Coils shall be tested at 300 psig (22 bars).
4. Integral face and bypass coils shall be provided with a connection point for field-mounted actuator(s), electrical or pneumatic, or can be provided from the factory at an additional cost.
5. Actuator connection point shall be mechanically attached to dampers via linkage mechanisms. Dampers shall be interconnected for operation simultaneously across each face of coil.

# Guide Specifications: Outdoor Air Handling Unit

## C. Face and Bypass Dampers:

### 1. Internal Face and Bypass Dampers:

Internal face and bypass dampers shall be factory mounted in galvanized steel frame. Damper blades shall be constructed of galvanized steel, with high temperature blade and edge seals. Blades shall be mechanically fastened to axle rods rotating in synthetic bearings. Face damper blades shall be opposed and arranged to match coil face with top bypass and internal linkage.

### 2. External Face and Bypass Dampers:

Face damper shall be factory mounted in galvanized steel frame. Damper blades shall be constructed of galvanized steel, with high temperature blade and edge seals. Blades shall be mechanically fastened to axle rods rotating in synthetic bearings. Bypass damper shall be constructed of galvanized steel, with blade seals and cambered steel jamb seals. Blades shall be mechanically fastened to axle rod rotating in synthetic bearings. Face damper blades shall be opposed with top bypass and internally mounted linkage.

## D. Multi-Zone Dampers:

Multi-zone dampers shall be factory mounted in galvanized steel frame. Damper blades shall be constructed of galvanized steel with blade seals and cambered steel jamb seals. Blades shall be mechanically fastened to axle rods rotating in synthetic bearings.

## 2.09 AIR BLENDER

The air blender shall mix two or more airstreams of differing temperature to a mixed-air temperature and provide a more uniform air velocity contour entering a downstream filter or coil bank.

## 2.10 UV-C GERMICIDAL LAMPS

Emitters and fixtures for UV lamps shall be designed for use inside an HVAC system.

A. Power supplies for UV lamps shall be a high-efficiency electronic type which are matched to the emitters and are capable of producing the specified output intensity with an input power no more than 80 watts.

B. Fixtures for UV lamps shall be factory installed and wired to a SPDT disconnect switch and door interlock switches in each door. Fixtures are wired for 120V/1Ø requiring a minimum circuit ampacity of 15 amps. Lamps shall ship separately for field installation to minimize the chance for bulb damage.

C. Emitters and fixtures shall be installed in sufficient quantity and arranged so as to provide an equal distribution of UV light on the coil and drain pan.

D. UV lights striking the strike the drain either directly or indirectly through reflection.

E. Emitters and fixtures shall be installed such that UV energy strikes all surfaces of the coil, drain pan and the available line of sight airstream.

## 2.11 ELECTRICAL ACCESSORIES:

### A. Marine Lights and Convenience Outlets:

1. Cast, non-ferrous metal, weatherproof, fixture.
2. Cast, non-ferrous metal, weatherproof, electrical junction box.
3. Sealed heat and shock resistant glass globe protects against moisture and debris.
4. Cast, non-ferrous metal lamp guard to protect glass globe.
5. UL listed.
6. 100 watt type 'A' lamp maximum capacity.
7. Each fixture is equipped with a 75 watt, 120V, long life, vibration resistant, lamp factory installed.
8. Metallic, single gang, electrical junction box, UL listed.
9. Convenience outlet: Factory supplied and wired, SPST, toggle

switch and 15 Amp, 120VAC/60Hz, NEMA 5-15 type, ground fault circuit interrupt (GFCI) receptacle, UL listed.

10. No convenience outlet: Factory supplied and wired, SPST, UL listed toggle switch.

11. Each fixture is factory wired to an externally mounted switch box. (Field power connections are made to the switch box mounted externally on the unit.)

12. All factory wirings penetrating through the panel is protected in 'RIGID' type metal conduit.

## B. Disconnects:

1. 115-230V/1Ø non-fused disconnects shall have the following characteristics:

a. Plated current carrying components for superior corrosion protection.

b. Factory-installed equipment grounding terminals with slot/square drive screws.

c. Rated for motor disconnects applications (10 HP / 7.5 Kw maximum).

d. NEMA type 3R non-metallic enclosure.

e. Up to 10,000 RMS symmetrical amperes SCCR, when protected by a fuse or circuit breaker rated 60 amperes or less.

f. Cover padlock hasp.

g. Pull-out cartridge type.

h. UL listed.

2. 115-230V/1Ø fused disconnects shall have the following characteristics:

a. Visible blades.

b. Quick-make, quick-break operating mechanism.

c. Cover padlock hasp and handle lock "OFF".

d. 240VAC maximum.

e. Factory supplied and installed class 'T Series' fuses (fused disconnects only).

f. Up to 10,000 RMS symmetrical amperes SCCR, utilizing appropriately rated factory supplied fuses.

g. Horsepower rated for motor applications.

h. Tangential combination knockouts for field wiring.

i. Spring reinforced plated copper fuse clips.

j. NEMA 1 type enclosures.

k. Insulated, bondable solid neutral assemblies.

l. UL listed, File E2875.

m. Meet or exceed NEMA KS1 Standard.

3. 200-230V/3Ø fused and non-fused disconnects shall have the following characteristics:

a. Visible blades.

b. Quick-make, quick-break operating mechanism.

c. Cover padlock hasp and handle lock "OFF".

d. 240VAC maximum.

e. Factory supplied and installed class RK5 fuses (fused disconnects only).

f. Up to 100,000 RMS symmetrical amperes SCCR, utilizing appropriately rated, factory supplied Class R fuses.

g. Horsepower rated for motor applications.

h. Tangential combination knockouts for field wiring.

i. Spring reinforced plated copper fuse clips.

j. NEMA 1 type enclosures.

k. Insulated, bondable solid neutral assemblies.

l. UL listed, File E2875.

m. Meet or exceed NEMA KS1 standard.



## Guide Specifications: Outdoor Air Handling Unit

4. 380-575V/3Ø fused and non-fused disconnects shall have the following characteristics:
    - a. Visible switch blades with for positive "OFF" indication.
    - b. Quick-make, quick-break operating mechanism.
    - c. Dual cover interlock.
    - d. Color coded "ON" / "OFF" indicator handle.
    - e. Cover padlock hasp and handle lock "OFF" provision for multiple padlocks.
    - f. 600VAC maximum.
    - g. Factory supplied and installed class RK5 fuses (fused disconnects only).
    - h. Up to 200,000 RMS symmetrical amperes SCCR, utilizing appropriately rated, factory supplied Class R fuses.
    - i. Horsepower rated for motor applications.
    - j. Spring reinforced plated copper fuse clips.
    - k. Tangential combination knockouts.
    - l. NEMA 1 type enclosures.
    - m. Insulated, bondable solid neutral assemblies.
    - n. Wire terminations suitable for aluminum or copper conductors.
    - o. UL listed.
    - p. Meet or exceed NEMA KS1 Standard.
- C. Starters:
1. Starter without disconnect:
    - a. Adjustable motor overload with trip indication.
    - b. Manual overload reset button (accessible without opening enclosure).
    - c. 115V fused secondary control transformer (fuse included — fused primary and secondary over 50 amps).
    - d. Hand/Off/Auto selector switch (accessible without opening enclosure).
    - e. Separate 4-position terminal strip for remote H-O-A wiring.
    - f. C series contactors.
    - g. Horsepower rated for motor applications.
    - h. NEMA 4X type non-metallic enclosures.
    - i. Lug connections for field wiring.
    - j. Factory mounted, wired and run tested with factory-supplied motor.
    - k. UL listed.
  2. Combination Starter/Disconnect:
    - a. Non-fused UL 508 Disconnect Switch with Lockable Handle (locks not provided).
    - b. Cover interlock.
    - c. Adjustable motor overload with trip indication.
    - d. Manual overload reset button (accessible without opening enclosure).
    - e. 115V fused secondary control transformer (fuse included — fused primary and secondary over 50 amps).
    - f. Hand/Off/Auto selector switch (accessible without opening enclosure).
    - g. Separate 4-position terminal strip for remote H-O-A wiring.
    - h. C series contactors.
    - i. Horsepower rated for motor applications.
    - j. NEMA 4X type non-metallic enclosures.
    - k. Lug connections for field power wiring.
    - l. Factory mounted, wired and run tested with factory-supplied motor.
    - m. UL listed.
- D. Bypass for Variable Frequency Drives:
1. 200-230V/3Ø/60Hz, 460-575V/3Ø/60Hz, 380V/3Ø/50Hz:
    - a. 4-position panel-mounted disconnect style switch with lockable handle (locks not provided), meets OSHA 1910.
    - b. Switch position indication (LINE/OFF/ DRIVE/TEST).
    - c. Adjustable motor overload with trip indication (LINE position).
    - d. Manual overload reset button.
    - e. Horsepower rated for motor applications.
    - f. Direct control (no contactors, relays or holding coils).
    - g. Complete isolation of inverter in LINE position.
    - h. NEMA 12 type metal enclosures.
    - i. Terminal strip provided for field power supply wiring.
    - j. Lug connection for field ground wire.
    - k. Gold flashed, auxiliary switch contact set (for switch position monitoring).
    - l. Factory mounted, wired to VFD and motor, and run tested (motor and VFD must be factory supplied and installed).
    - m. UL; UL, Canada; CE listed.
  2. 200-230V/3Ø/60Hz, 460-575V/3Ø/60Hz, 380V/3Ø/50Hz:
    - a. 4-position panel-mounted disconnect style switch with lockable handle (locks not provided), meets OSHA 1910.
    - b. Switch position indication (LINE/OFF/DRIVE/TEST).
    - c. Adjustable motor overload with trip indication (in LINE position).
    - d. Manual overload reset button.
    - e. Horsepower rated for motor applications.
    - f. 115V control transformer with fused secondary (fused primary on units over 50 amps).
    - g. Contactor for Line Start/Stop.
    - h. Door-mounted Line Start and Line Stop pushbuttons.
    - i. Complete isolation of inverter in LINE position.
    - j. NEMA 12 type metal enclosures.
    - k. Terminal strip provided for field power supply wiring.
    - l. Lug connection for field ground wire.
    - m. Gold flashed, auxiliary switch contact set (for switch position monitoring).
    - n. Factory mounted, wired to VFD and motor and run tested (motor and VFD must be factory supplied and installed).
    - o. UL; UL, Canada; CE listed.
- E. Variable Frequency Drives:
1. Factory mounted Variable Frequency Drives (VFDs) shall be wired to factory-supplied motors.
  2. The VFD parameters are programmed into the controller and removable keypad. In the event that the VFD fails and needs replacement, the program can then be uploaded to the replacement VFD via the original keypad.
  3. The VFD package as specified herein shall be enclosed in a UL Listed type enclosure, exceeding NEMA enclosure design criteria (enclosures with only NEMA ratings are not acceptable), completely assembled and tested by the manufacturer in an ISO 9001 facility.
- Manufacturer reserves the right to discontinue, or change at any time, specifications or designs without notice and without incurring obligations.**
- Thermal Corporation, Inc. A Division of Nailor International, Inc.,  
Houston, Texas 77039 5-20-13

4637 Winfield Road, Houston, TX 77039

Tel: 281-590-1172 • Fax: 281-590-2751

[www.thermal-corp.com](http://www.thermal-corp.com)

**Thermal Air Handlers For Thermal Comfort.**



***THERMAL***  
**CORPORATION**

*A Division of Nailor International, Inc.*





# Blower Coil

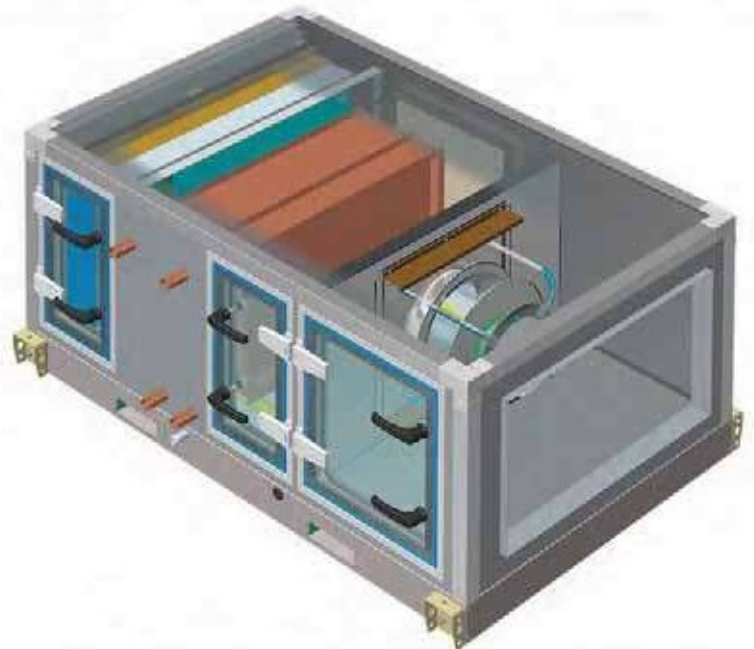

**THERMAL**  
CORPORATION

*A Division of Nailor International, Inc.*

## Blower Coil

Thermal Corp. HBC (Horizontal Blower Coil) and VBC (Vertical Blower Coil) Series indoor air handling units provide solutions! Challenging applications and setups, those typically reserved for custom built equipment, like 100% dedicated outdoor air, filtration, dehumidification, energy recovery and reheat are a few of the solutions Thermal's HBC and VBC Series will deliver. With multiple footprint options, pre-engineered models and flexible modular options, HBC and VBC Series provide quicker delivery times with flexible features, much more cost competitively than fully custom units.

### FEATURES

- HBC & VBC Series units offer from 1,000 to 10,000 CFM ranges, with single or multiple fan configurations.
- Heat recovery configuration allows for energy efficient heating and cooling requirements.
- Make up air capability, up to 100% outside air, to meet ventilation requirements.
- Factory installed, up to 8 rows combined, high performance chilled and hot water, steam and DX coils.
- Multiple high efficiency filtration options, with up to a MERV 14 efficiency rating.
- Factory built, installed and wired electric heat.
- HBC series are available in 5 different low profile horizontal sizes from 34" to 50" (864 to 1270) in height for overhead or low clearance ceiling installations.
- VBC series are available in 5 different vertical sizes which are designed for small space or mechanical rooms with narrow clearances [width from 28" to 76" (711 to 1930), length from 34" to 48" (864 to 1219)].

**Model VBC**

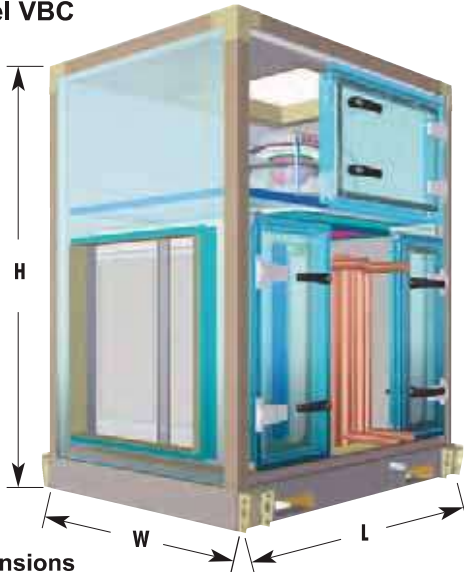

**Dimensions**

Models	H	L	W
<b>VBC1</b>	60 (1524)	48 (1219)	28 (711)
<b>VBC2</b>	60 (1524)	48 (1219)	40 (1016)
<b>VBC4</b>	70 (1778)	48 (1219)	54 (1372)
<b>VBC6</b>	80 (2032)	48 (1219)	76 (1930)
<b>VBC10</b>	92 (2337)	48 (1219)	76 (1930)

### CONSTRUCTION

- Double wall rigid cabinet construction injected with polyurethane foam, is thermally isolated with closed cell insulation to prevent heat transfer and condensation between panels. Laminate construction makes the cabinet more rigid and resistant to damage, provides optimum sound dampening and reduces air leakage.
- Right or left handed piping connections and service access doors, with hinges and lockable door handles, improve serviceability, reduce installation and maintenance time.
- Double sloped stainless steel drain pan, eliminates standing water which can support microbial growth. Stainless steel construction prevents corrosion that could lead to water leaks and contaminants in the air stream.
- ECM (Electrically Commutated Motor) direct drive, backward curved, plenum supply fans provide precise airflow control and reduced power consumption. ECM's are more energy efficient, quieter and require less maintenance than conventional belt driven fans.
- Factory provided or customer provided controller can be selected to meet existing or new building control architecture.
- SCR (Silicon Controlled Rectifier) electric heat control for reduced power consumption, longer heater life and improved occupant comfort
- Polymer e-coated coils are available to extend the life of the coils and protect them in corrosive environments.

**Model HBC**

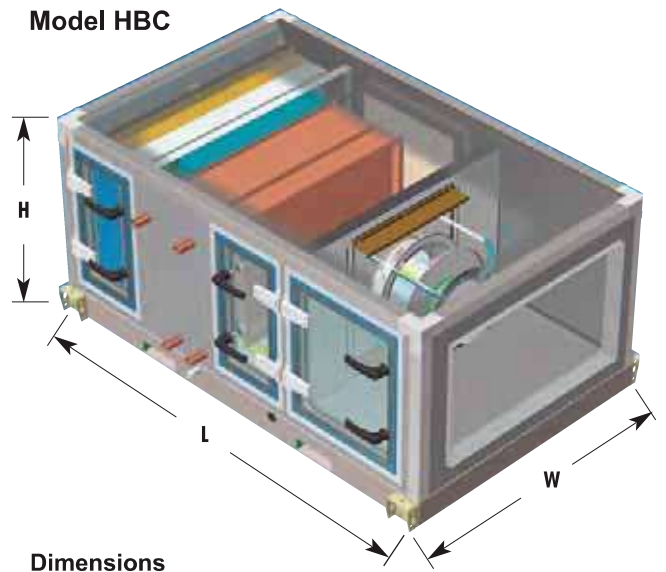

**Dimensions**

Models	H	L	W
<b>HBC1</b>	34 (864)	72 (1829)	34 (864)
<b>HBC2</b>	34 (864)	72 (1829)	44 (1118)
<b>HBC4</b>	38 (965)	72 (1829)	64 (1626)
<b>HBC6</b>	38 (965)	76 (1930)	84 (2134)
<b>HBC10</b>	50 (1270)	76 (1930)	98 (2489)

Dimensions are in inches (mm)



**OPTIONS**

Each Thermal Corp HBC/VBC unit can be customized by selecting the appropriate predefined module or modules, to meet the most stringent project demands. The base HBC/VBC unit consists of a fan, coil and filter section. HBC/VBC series units are available without integral filter sections. From there, a pre-filter, electric heat, return/exhaust fan or humidifier module may be added as needed to meet specific project requirements. The flexibility of the HBC/VBC units allows for these modules to be added at later times, if budget, sizing or other factors facilitate that requirement. Since the modules are all constructed in the same manner, you can be assured that the unit will look and assemble seamlessly.

Below are a few of the individual modules:

**Dimensions**

Models	OPTION VSC*		
	H	L	W
VBC1	60 (1524)	34 (864)	28 (711)
VBC2	60 (1524)	34 (864)	40 (1016)
VBC4	70 (1778)	34 (864)	54 (1372)
VBC6	80 (2032)	34 (864)	76 (1930)
VBC10	92 (2337)	34 (864)	76 (1930)

\*Option VSC: Short Cabinet without filter section

**Dimensions**

Models	OPTION HSC*		
	H	L	W
HBC1	34 (864)	60 (1524)	34 (864)
HBC2	34 (864)	60 (1524)	44 (1118)
HBC4	38 (965)	60 (1524)	64 (1626)
HBC6	38 (965)	64 (1626)	84 (2134)
HBC10	50 (1270)	64 (1626)	98 (2489)

\*Option HSC: Short Cabinet without filter section

**HBC/VBC AIRFLOW RANGE/NO. OF FAN**

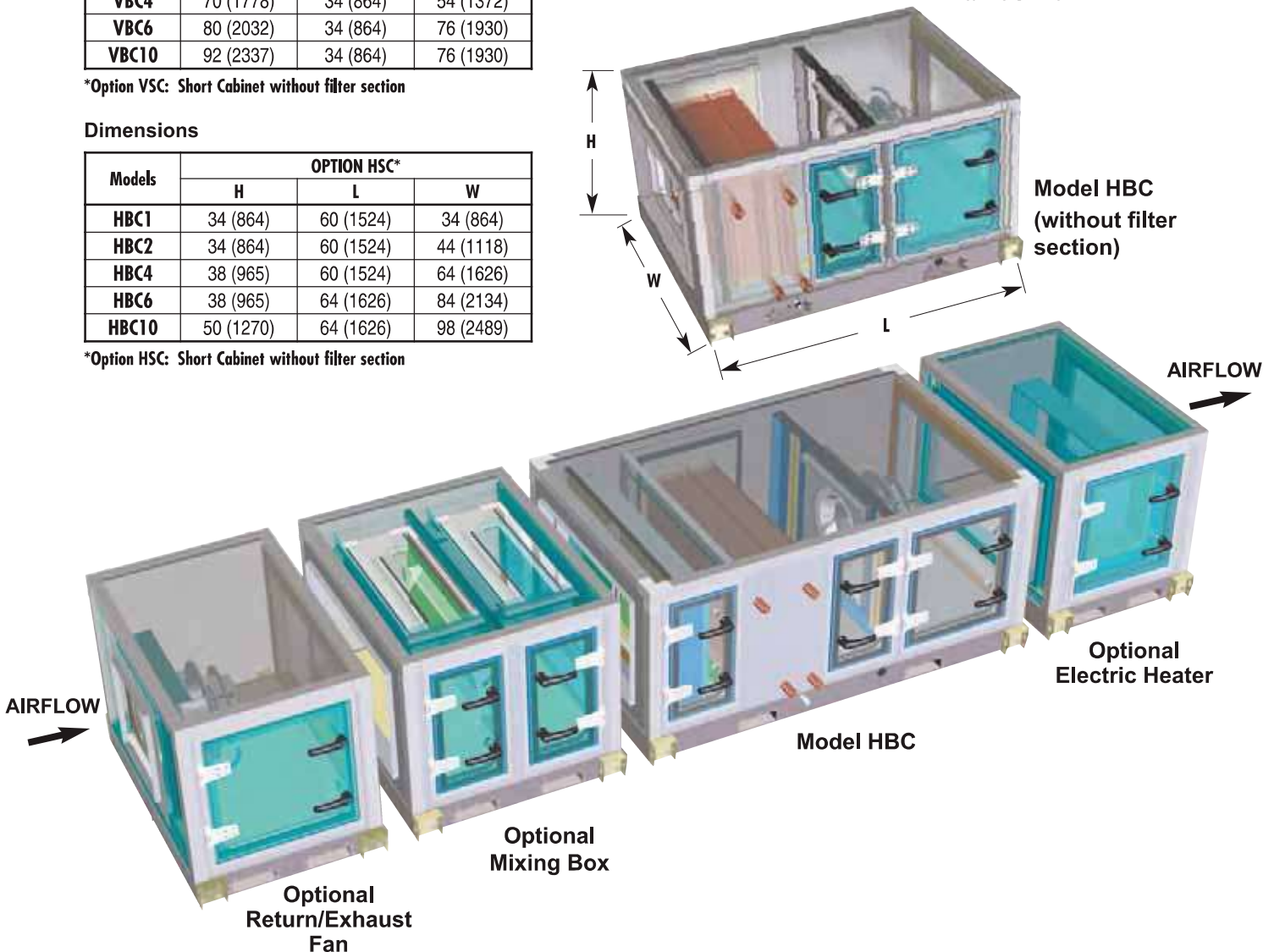
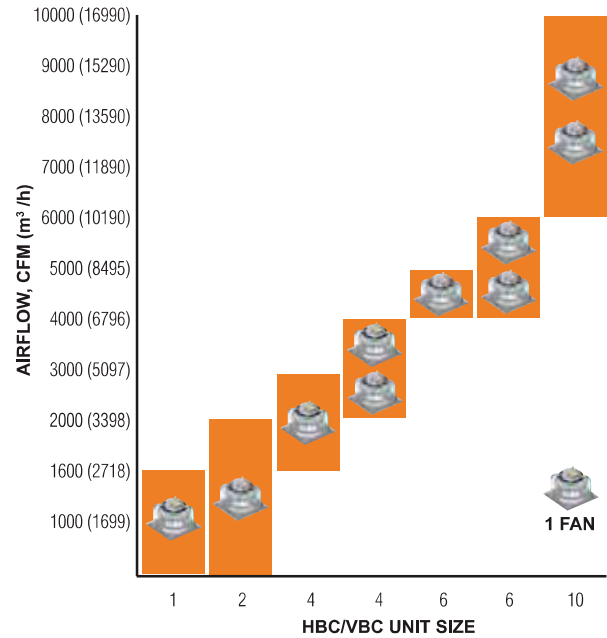

Blower Coil





4637 Winfield Road, Houston, TX 77039  
Tel: 281-590-1172 • Fax: 281-590-2751  
[www.thermal-corp.com](http://www.thermal-corp.com)

**Thermal Air Handlers For Thermal Comfort.**

***THERMAL***  
**CORPORATION**

*A Division of Nailor International, Inc.*

# THERMAL CORPORATION

*A Division of Nailor International, Inc.*



## Tranquility Column Unit





## Tranquility Column Unit

Thermal's Tranquility Column Unit (TCU) is designed to mix multiple airstreams and provide the conditioned air to an underfloor space or plenum. The TCU series provides a very flexible approach to underfloor systems by utilizing a variety of options. Whether used as a primary booster, primary or supplemental cooling, dedicated outdoor air or a pre-treated, primary air stream mixed with space return air, the series will accommodate almost any underfloor application.

### FRAME

Borrowing Thermal's CF, F and T Series frame construction techniques, each TCU unit can be customized to offer varying degrees of structural rigidity or modularity, while providing economical solutions to meet project specifications.

Thermal's Tubular Frame (T Series) construction is the standard frame design on TCU Series. This rigid structural design, allows for a wide range of size and configurations while providing a customizable platform with an optimal balance in strength, quality and value.

### PANELS

Unit exterior panels are constructed of galvanized steel. They may be screwed to the standard tubular welded frame (T Series), to die-formed welded frames (CF Series) or to the bolted unitized frame (F Series). All side, end and roof panels provide a smooth, flush, pleasing appearance. Panels are sealed with closed cell neoprene gaskets around the perimeter. A few features include:

- 16 gauge (1.5) galvanized steel panels
- Closed cell neoprene gasketing
- Installed with ¼" (6) sealed fasteners
- All panels are removable without affecting structural integrity of the unit
- 2" (51), 3" (76) or 4" (102) walls are available with single or double wall construction

#### Options:

- Epoxy coated painted casing
- 304SS or 316SS exterior and/or interior

#### Liner:

Interior of walls, roof, doors, frame and floor lined with 20 ga. (1.0) perforated galvanized steel sheet.

#### Options:

- 304 or 316 Stainless steel

### INSULATION

Entire casing insulated with 2" (51) thick, 3 lb/ft<sup>3</sup>. (48 kg/m<sup>3</sup>) density FSK faced fiber insulation, rated and marked for compliance with NFPA 90A and 90B.

Insulation is applied with 100 percent coverage of a bonding adhesive.

#### Options:

- 2" (51) thick, 3 lb/ft<sup>3</sup> (48 kg/m<sup>3</sup>) density mat faced insulation
- 3" (76) thick, 3 lb/ft<sup>3</sup> (48 kg/m<sup>3</sup>) density mat faced insulation
- 3" (76) thick, 3 lb/ft<sup>3</sup> (48 kg/m<sup>3</sup>) density FSK faced insulation

### ACCESS DOORS

Double wall, hinged and latched access doors are provided for fan access, filter access and the controls vestibule. Access doors are constructed with the same materials as the unit casing specified above.

Gasket: Closed cell neoprene bulb.

Hinge (Where Necessary): 3-Way Adjustable zinc plated.

Handles: Durable glass reinforced nylon construction.

#### Options:

- Fan access doors provided with a 12" (305) x 12" (305) Lexan view glass window
- Key-locking door handles

### FANS AND MOTORS

Fans selected are direct drive SWSI airfoil 12 blade plenum, with sizes as shown on the tables.

Unit fan selection and ratings shall be based on tests made in accordance with ASHRAE 51, AMCA 210, and AHRI 430.

Fans are selected to be capable of operating safely at every point of rating on or below the minimum performance class limit and have stable operation over the entire operating range from shut off to free delivery.

Fan and motor assembly mounted on a tubular steel roll out base, isolated from the unit frame with un-housed, bolted spring type vibration isolators having a minimum of 1" (25) deflection. A neoprene coated flexible connector with quick release latch is provided between fan and inlet panel. Fan base is coated with self-priming urethane enamel.

Motors selected are 900 RPM, ODP standard efficiency, with horsepower as shown on the tables and voltage as determined by project specifications.

#### Options:

- Seismic restraints
- TEFC or P Motors
- Premium Efficiency motors

### FILTER SECTION (Optional)

Filter section is equipped with a latched access door on the front of the unit casing. This allows filters to be changed from within the mechanical room closet.

#### Options:

- 2" (51) thick, pleated media type
- 4" (102) thick, pleated media type

Dimensions are in inches (mm)

# Tranquility Column Unit

## Model TCU

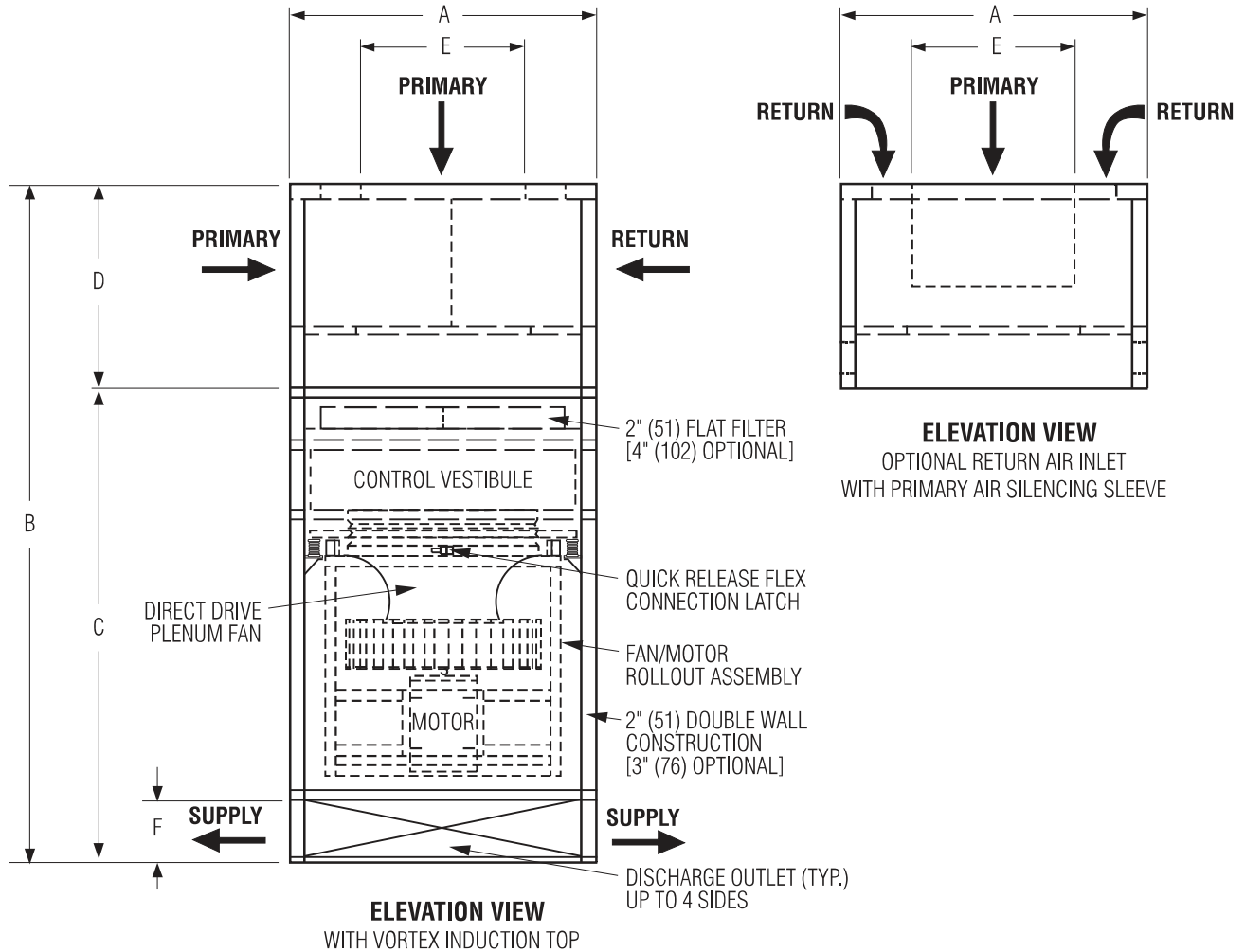

Model	CFM (l/s) Range	A	B	C	D	E	F
TCU-500	3,000 - 5,000 (1416 - 2360)	54 (1372)	127 <sup>1</sup> (3226)	91 <sup>1</sup> (2311)	36 (914)	Project Specific	Project Specific
TCU-1000	7,500 - 10,000 (3539 - 4719)	58 (1473)	135 <sup>2</sup> (3429)	99 <sup>2</sup> (2515)	36 (914)	Project Specific	Project Specific
TCU-1500	13,000 - 15,000 (6135 - 7079)	66 (1676)	161 <sup>3</sup> (4089)	116 <sup>3</sup> (2941)	45 (1143)	Project Specific	Project Specific

<sup>1</sup> - 12" used for F dimension to determine B and C.

<sup>2</sup> - 18" used for F dimension to determine B and C.

<sup>3</sup> - 24" used for F dimension to determine B and C.

Model	Filter Area Sq. ft. (m <sup>2</sup> )	Max Filter Velocity fpm (m/s)	Filter Sizes		Fan Size	Motor hp (kW)	Motor RPM	NC Rating
			Qty.	Size				
TCU-500	13.33 (1.24 m <sup>2</sup> )	375 (1.91)	6	16 x 20 (406 x 508)	27 (686)	2 (1.49)	900	37
TCU-1000	18.00 (1.67 m <sup>2</sup> )	555 (2.82)	6	18 x 24 (457 x 610)	36.5 (927)	5 (3.73)	900	40
TCU-1500	22.22 (2.06 m <sup>2</sup> )	675 (3.43)	8	16 x 25 (406 x 635)	40 (1016)	5 (3.73)	900	45

Dimensions are in inches (mm)



4637 Winfield Road, Houston, TX 77039

Tel: 281-590-1172 • Fax: 281-590-2751

[www.thermal-corp.com](http://www.thermal-corp.com)

**Thermal Air Handlers For Thermal Comfort.**

**THERMAL**  
**CORPORATION**

*A Division of Nailor International, Inc.*